

amop[®]
synergies

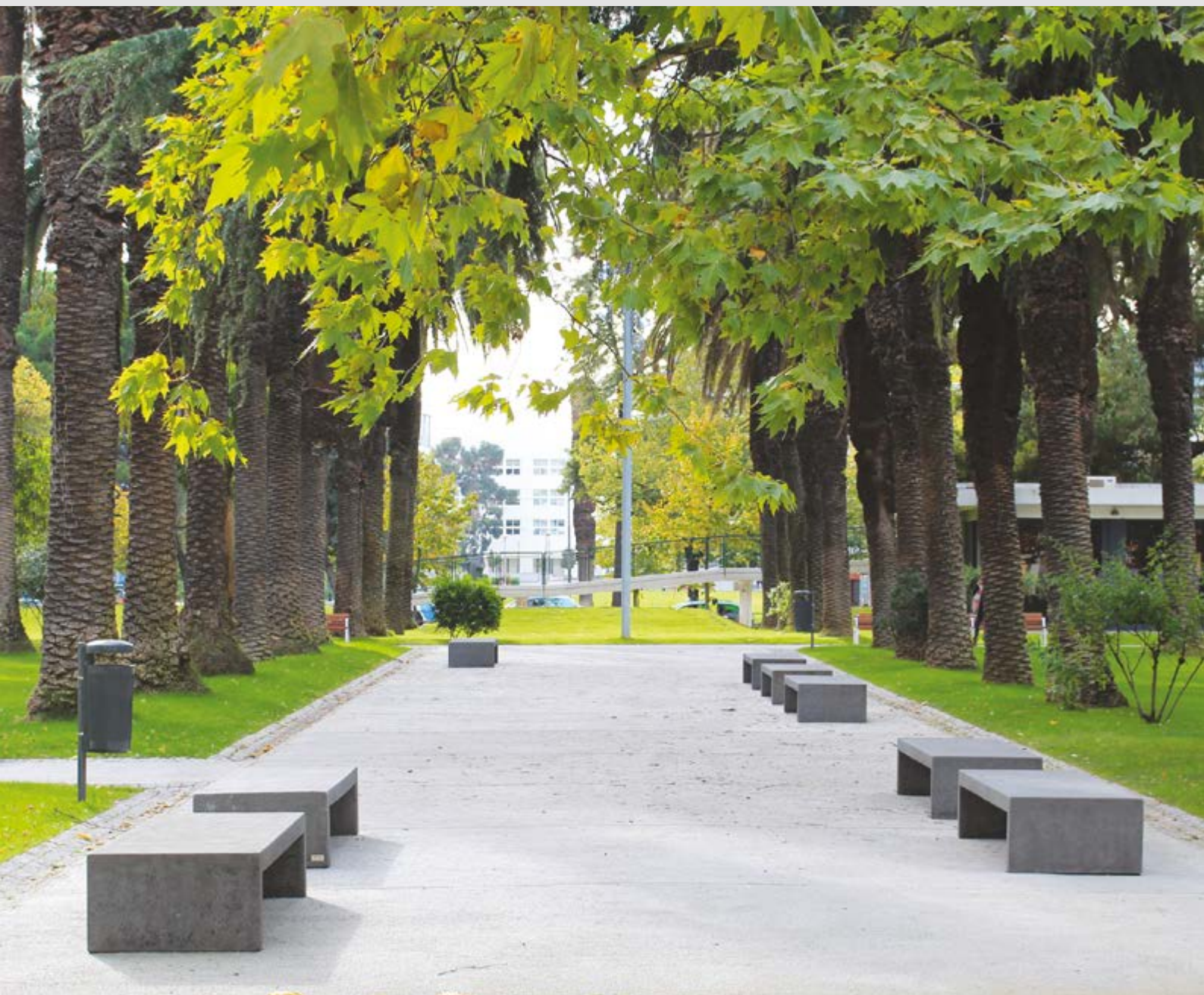

Urban & Private

Mobilier, Sols et Revêtements en Béton
Mobiliario, Pavimentos y Revestimientos de Hormigón

A Empresa

Experiência

Amop Synergies®, fundada em 1973, tem uma história industrial de meio século, dedicada à concepção e produção de peças em betão e pedra reconstituída, comercializando soluções integradas para arquitetura e paisagismo. É líder em Portugal e compete como marca especializada de referência internacional.

Confiança

Com uma equipa de 60 funcionários e instalações que ocupam uma área total de 50.000 m², a Amop detém a capacidade de resposta e o saber-fazer para os projectos mais exigentes no que respeita ao desenvolvimento de produtos em betão. O mobiliário da Amop está presente em locais emblemáticos de países como Alemanha, Áustria, Bélgica, Espanha, Itália, França, Inglaterra, Irlanda, Marrocos, Polónia, Suíça, Suécia, Lituania, Israel, Sérvia e EUA.



The Company

Experience

Amop Synergies ®, founded in 1973, displays half of a century of industrial history dedicated to the creation and manufacture of concrete and reconstituted stone products, by trading integrated solutions for architecture and landscaping. It is leader in Portugal and competes as a specialized brand of international renown.

Confidence

With a team of 60 employees and a total area of 50.000m² in facilities, Amop holds the know-how and skill to respond to the most demanding projects, in terms of development of products made from concrete.

Amop Synergies ® furniture stands in emblematic locations of countries such as Germany, Austria, Belgium, Spain, Italy, France, England, Ireland, Morocco, Poland, Switzerland, Sweden, Lithuania, Israel, Serbia and USA.



A Empresa

Do Design à Produção

A estratégia integrada de desenvolvimento da Amop é a aposta no design, nas pessoas e no saber-fazer industrial. Cooperamos com designers e arquitectos no desenvolvimento das linhas de mobiliário do catálogo que respondem às necessidades de equipamento para espaços urbanos, espaços de hotelaria e espaços privados. A Amop adequa soluções à especificidade de cada projecto, contexto e público-alvo e, para esse fim, conta com estreitas parcerias, especializadas nos componentes não-cimentícios que incorporam os seus produtos.

Qualidade Amop

- Fabrico nacional, de alta-qualidade, com as melhores matérias primas e o saber-fazer de 50 anos de actividade.
- Concepção e fabrico tendo como metas a durabilidade, fácil manutenção e adequação a situações de uso intensivo.
- Conceptualização elaborada por designers experientes em estreita colaboração com o departamento de engenharia.
- Coleções de mobiliário, pavimentos e revestimentos que podem ser utilizados isoladamente ou em complementaridade com outras peças ou produtos Amop.
- Empresa certificada pela norma ISO 9001: 2015.



The Company

From Design to Production

The integrated development strategy of Amop is to focus on design, the people and industrial know-how.

We cooperate with designers and architects to develop the catalogue's furniture lines that meet the needs of urban, hospitality and private spaces. Amop adapts solutions to the particularities of each project, context and target group and, to attain that goal, the company maintains close partnerships specialized in cementless components incorporated in its products.

Amop Quality

- High quality, made in Portugal production, with the best raw materials and 50 years of age know-how.
- Conception and manufacture with the purpose of durability, easy maintenance and suitability for intensive use.
- Concepts made by experienced designers in a close collaboration with the engineering department.
- Collection of urban furniture, pavings and claddings that can be used individually or combined with other parts or Amop products.
- ISO 9001: 2015 certified company.



Os Produtos

Vantagens Amop

Peças em betão arquitetónico, pedra reconstituída e outros materiais nobres. Concebidos para os espaços públicos e privados, com design, garantindo a elevada resistência, estabilidade e baixa manutenção.



AR PURO

Assentos, Mesas, Papeleira, Bebedouro, Dissuasor, Floreiras, Stop Bicicletas, Guarda Corpos.
Seats, Tables, Paper Bins, Fountain, Bollards, Planters, Bicycle Rack, Body Guards.

pág. 18



AR PURO +

Cadeiras e Bancos Individuais e Colectivos, Mesas, Stop Bicicletas, Guarda Corpos.
Individuals and collective Benches and Chairs, Tables, Bicycle Rack, Body Guards.

pág. 22



AMOPLAY

Bancos, Mesas, Mesa Ping Pong, Mesa de Futebol/ Voleibol, Parede Giz.
Benches, Tables, Ping-Pong Table, Football/ Volleyball Table, Chalk Wall.

pág. 26

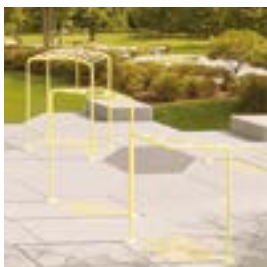

EXERCISE

Equipamentos de exercício exterior.
Workout outdoor equipments.

pág. 30



BENAVENTE

Bancos de configuração de lagos e jardins.
Lake and garden configuration benches.

pág. 35



LANDSCAPES

Bancos, Floreiras, Lareira, Elementos de Paisagem.
Benches, Planters, Fireplace, Landscapes Elements.

pág. 36



CELL FORMS

Floreiras e Caldeiras de Grande Escala.
Large scale Planters and Tree Surrounds.

pág. 40



MATADI

Bancos e Elementos de Paisagem.
Benches and Landscapes Elements.

pág. 42



DNA

Bancos Corridos e Composições Orgânicas.
Straight Benches and Organical Compositions.

pág. 44



LIVRE

Bancos e Mesas.
Benches and Tables.

pág. 45

The Products

Amop Benefits

Pieces in architectonic concrete, reconstituted stone and other noble materials. Made for public and private spaces, with design that insures high resistance, stability and low maintenance.



DOLMA

Floreiras e Bancos, Médios e Grandes.

Planters and Medium and Big Benches.

pág. 46



MODO

Bancos, Floreira, Mesa e Composições Orgânicas

Benches, Tree Surround, Table and Organic Compositions.

pág. 48



AMENO

Bancos, Floreiras, Sombreador e Composições Orgânicas.

Benches, Planters, Sun Shader and Organical Compositions.

pág. 50



GRIP

Bancos, Cadeiras, Floreiras e Papeleiras.

Benches, Chairs, Planters and Paper bins.

pág. 52



MODULAR

Bancos, Mesas, Bebedouro, Stop Bicicleta, Floreiras, Caldeira.

Benches, Tables, Fountain, Bicycle Rack, Planters and Tree Surrounds.

pág. 54



BASICS

Bancos, Floreiras, Totens, Stop Bicicletas, Dissuasores, Caldeiras, Estação Serviço, Pérgulas, Anfiteatro.

Benches, Planters, Totens, Bicycle Racks, Bollards, Tree Surrounds, Service Station, Pergolas and Amphitheatre.

pág. 58



R-LIGHT

Bancos Individuais e Colectivos, Floreiras Pequenas, Altas e Grandes, Papeleiras.

Individual and Collective Benches, Small, Tall and Big Planters, Paper Bins.

pág. 70



E' LEVE

Banco e Pavimento Mega-Lajetas.

Bench and Mega-Slab Paving.

pág. 73



SOCIAL PLAY

Banco, Cadeira e Espreguiçadeira, Corrido e Modular, Grande Escala.

Bench, Chair and Chaise Long, Straight and Modular Bench, Big Scale.

pág. 74



COIMBRA

Bancos, Assentos e Encosto, Composições Orgânicas.

Benches, Seats and Backrest, Organic Compositions.

pág. 78

Os Produtos



LORD

Cadeiras e Bancos Individuais e Coletivos, Mesas, Floreiras, Dissuasor, Papeleira.

Individual and Collective Chairs and Benches, Tables, Bollard, Paper Bin.

pág. 80



PLANO

Bancos, Assentos e Encosto, Totem.

Benches, Seats and Rest, Totem.

pág. 82



OBLONG

Banco Caldeira Modular, Grande Escala.

Modular Tree Surround Bench, Big Scale.

pág. 84



MINIMAL

Cadeira Individual e Dupla.

Individual and Double Chair.

pág. 85



LUGAR COMUM

Cadeiras, Bancos, Mesas, Papeleiras, Bebedouro, Floreiras.

Chairs, Benches, Tables, Paper Bins, Fountain and Tree Surrounds.

pág. 86



MIA

Banco Reto, Banco Concavo e Convexo, Corridos Modulares, Papeleira, Bebedouro, Dissuasor.

Straight, Concave and Convex Bench, Modular Straight Benches, Paper Bin, Fountain, Bollard.

pág. 94



AM

Bancos Reto e Curvos, Corridos Modulares, Mesa, Pic-nic, Papeleira.

Straight and Curved Benches, Modular Straight, Table, Picnic, Paper Bin.

pág. 96



CITIZEN

Bancos, Floreiras, Papeleiras, Ecopontos.

Benches, Planters, Paper Bins, Recycling Bins.

pág. 98



MATEUS

Bancos, Mesas, Papeleiras.

Benches, Tables, Paper Bins.

pág. 100



ÁGUEDA

Bancos com e sem Painel.

Benches with and without Panel.

pág. 102

The Products



HYBRID

Papeleiras, Dissuasores,
Cinzeiros.

Paper Bins, Bollards, Ashtrays.

pág. 104



GEOMETAL

Bancos de Encostar, Floreiras,
Bebedouro, Stop Bicicleta,
Papeleiras, Caldeiras.

*Back Seat, Planters, Fountain,
Bicycle Rack, Paper Bins, Tree
Surrounds.*

pág. 106

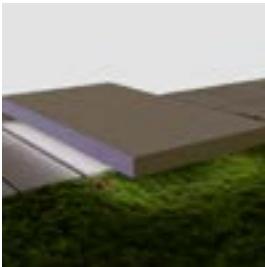

MUNDA

Banco, Grande Escala.
Bench, Big Scale.

pág. 112



FRESTA

Banco, Mesa, Papeleira.
Bench, Table, Paper Bin.

pág. 113



TEJO

Bancos Retos, Concavos e
Convexos, Corridos Modulares.
*Straight, Concave and Convex
Benches, Modular Straight.*

pág. 114



CONFORT

Banco Individual e Coletivo,
Assentos e Encostos.

*Individual and Collective Bench,
Seats and Backrest.*

pág. 118



TOKYO

Banco Individual e Coletivo,
Papeleira, Bebedouro, Assento e
Encosto.

*Individual and Collective Bench,
Paper Bin, Fountain, Seats and
Backrest.*

pág. 120



MUL

Floreiras e Bancos, Ilhas Verdes.
*Planters and Benches, Green
Islands.*

pág. 122



VOUGA RIO

Mesas, Bancos, Churrasqueira,
Lava Louça.

*Tables, Benches, Barbecue,
Outdoor Kitchen Sink.*

pág. 124



GÓIS

Cadeira Individual e Coletiva,
Picnic, Bebedouro, Papeleira e
Totem.

*Individual and Collective Chair,
Picnic, Fountain, Paper Bin and
Totem.*

pág. 126

Os Produtos



FRAME

Bancos e Cadeiras, Retas, Concavas e Convexas, Espreguiçadeiras Duplas e Individuais, Papeleiras

Straight, Concave and Convex Benches and Chairs, Individual and Double Chaise Long, Paper Bins.

pág. 128



CRU

Banco Individual e Coletivo, Floreira Pequena e Grande.

Individual and Collective Bench, Small and Big Planter.

pág. 134



WISE

Bancos com e sem Costas, Bancos Retos, Concavos e Convexos.

With or Without Backrest, Straight, Concave and Convex Benches.

pág. 136



LINK

Banco Reto e Curvo.

Straight and Curved Bench.

pág. 137



SPINNER

Banco Lúdico.

Ludic Bench.

pág. 138



CAMDEN

Banco.

Bench.

pág. 139



AVEIRO

Banco Reto e Curvo.

Straight and Curved Bench.

pág. 140



COMPORTA

Banco Individual e Coletivo, Assentos e Encostos.

Individual and Collective Bench, Seats and Backrests.

pág. 142



IK

Floreiras e Papeleiras.

Planters and Paper Bins.

pág. 144



ALGECIRAS

Banco.

Bench.

pág. 145

The Products

URBAN

R7M

Banco Recto e Curvo, Corrido Modular.

*Straight and Curved Bench,
Straight Modular Bench.*

pág. 146



LC

Bancs.

Short and Tall Bollards.

pág. 147



ADD-ONS

Sistemas de Assentos e Encostos
Seat and Backrest Systems.

pág. 148



PUMP TRACKS

Circuitos de Lombas, para Skate,
BMX, Patins, Trotinetas.

*Pump Circuits, for Skate, BMX,
Rollerblades, Scooters.*

pág. 152



ROUND UP

Mesas Redondas.

Round Tables.

pág. 170



MINI RAMPS

Half Pipe, para Skate, BMX,
Patins, Trotinetas.

*Half Pipe, for Skate, BMX,
Rollerblades, Scooters.*

pág. 157



WAVE RAMPS

Rampas de Surf skate, para Skate,
BMX, Patins e Trotinetas.

*Surfskate Ramps, for Skate, BMX,
Rollerblades, Scooters.*

pág. 161



PARKLETS

Mini Parques / Micro Praças.

Mini Parks / Micro Squares.

pág. 165



SCREEN

Floreira, Vedação, Mesas,
Bancos e Cadeiras.

*Planter, Fence, Tables, Benches
and Chairs.*

pág. 172

PRIVATE

Os Produtos



FLOW

Espreguiçadeiras, Cadeira,
Mesas de Apoio.
*Chaise Longs, Chair, Support
Table.*

pág. 178



MEGA-LAJETAS

Pavimentos Retilíneos Modulares,
Grandes Formatos.
*Straight-lined Modular Floors, Big
Scale.*

pág. 180



LAREIRA

Lareira.
Fire Pit.

pág. 181



DISTINTUS ACETINADO

Superfície Meio Brilho, Tipo
Terrazzo.
*Semi Shine Surface, Terrazzo
Type.*

pág. 186



DISTINTUS DESBASTADO

Superfície Desbastada, Tipo
Pedra Serrada.
Honed Surface, Sawn Stone Effect.

pág. 188



DEGRAU

Peça Degrau.
Block Step.

pág. 181



SALINAS

Pavimentos Hexagonais
Modulares, Grandes Formatos.
*Hexagonal Modular Pavings, Big
Scale.*

pág. 182



ORIGAMI

Lareiras de Exterior em Aço
Corten.
Outdoor Corten Steel Fire Pits.

pág. 183



ESTILHADUS

Superfície Bujardada Forte.
Strong Sandblasted Surface.

pág. 190



TIRA

Superfície desbastada mate ou
bujardada forte.
*Matte rough surface or strong
sandblasted surface.*

pág. 193

The Products



DIAGONAL

Superfícies pedra natural aparente, arestas serradas.
Fairfaced Natural Stone Surfaces, Sawed Edges.

pág. 194



TIRA BETÃO

Superfície Betão Natural Aparente.
Fairfaced Natural Concrete Surface.

pág. 196



COMPLEMENTOS

Complements

pág. 197



SAND_STONE

Superfície riscada suave.
Smooth scratch surface.

pág. 198



CONCRETE_STONE

Superfície riscada suave.
Smooth scratch surface.

pág. 200



GRANALHADUS

Superfície bujardada suave.
Soft Sandblasted Surface.

pág. 204

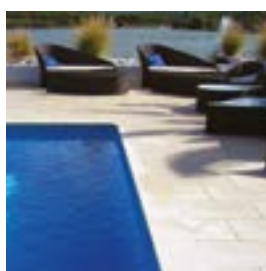

LONGUS

Superfície Bujardada, Ondulada Suave.
Wavy Smooth Sandblasted Surface.

pág. 206



TOSKANA

Superfície Bujardada Suave, com Sulcos.
Soft Sandblasted Surface, With Grooves.

pág. 208



ACESSOIRES POUR PISCINES

Bordaduras de Piscina, Cunhas e Cantos.
Pool Surrounds, Wedges and Corners.

pág. 209



TIRA

Superfícies Bujardado Suave, Topos Não Serrados.
Soft Sandblasted Surface, Non-Sawn Edges.

pág. 210

Os Produtos

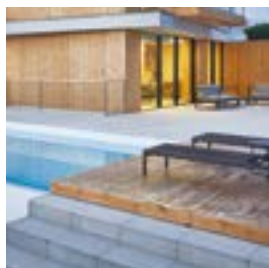

DEGRAUS E RODAPÉS

Degraus, Espelhos e Rodapés.
Step Parts, Mirrors and Skirting-Boards.

pág. 211



ESTEREOTOMIAS

Outros Desenhos e Configurações.
Other Designs and Settings.

pág. 212

MONO K

PAVINGS



PAVIMENTO TÁTIL

Pavimento Perigo, Direcional e Cautela, de Acordo com NP 4564.

Blister, Directional Guidance Attention Surface, in accordance with NP 4564.

pág. 215

The Products

SUSTENTABILIDADE

SUSTAINABILITY

Compromissos Ambientais.
Environmental Commitments.
 Pág. 219

TIPO DE INSTALAÇÃO

INSTALLATION TYPE

Mono K.
 pág. 222
 Urban e Private
 Pág. 223

MATERIAIS E ACABAMENTOS

MATERIALS AND FINISHES

Urban
 Pág. 224

Private
 Pág. 225

Mapa Global de Materiais
Global Materials Map
 Pág. 226

Materiais
Materials
 Pág. 227



AÇO CORTEN

CORTEN STEEL

Caracterização do Aço Corten.
Corten Steel Features.

pág. 229

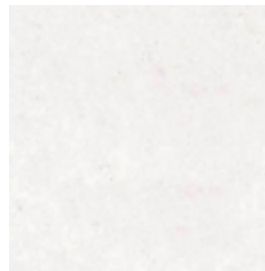

BETÃO UHPC

UHPC CONCRETE

Material e Acabamentos do
 Betão UHPC.
*UHPC Concrete's Material and
 Finishes.*

pág. 230



BETÃO RECICLADO

RECYCLED CONCRETE

Material e Acabamentos do
 Betão Reciclado.
*Recycled Concrete's Material and
 Finishes.*

pág. 232



BETÃO CS/ES

CS/ES CONCRETE

Material e Acabamentos do
 Betão CS/ES.
*CS/ES Concrete's Material and
 Finishes.*

pág. 234

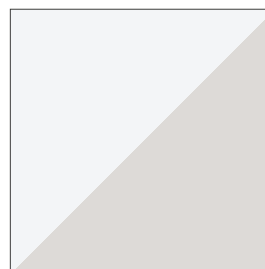

REVESTIMENTO PROTETOR

PROTECTIVE COATING

Acabamentos Covercrete.
Covercrete Finishes.

pág. 237

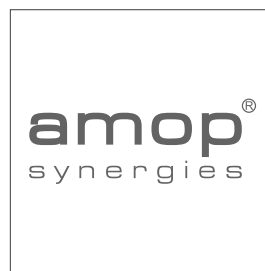

GARANTIA AMOP

AMOP WARRANTY

Garantia da Marca.
Manufacturer's Warranty.

pág. 238





URBAN

CARACTERÍSTICAS

Mobiliário de autor.
Design icónico em betão
arquitetónico e outros materiais
nobres, com alta qualidade
na fabricação, acabamento
manual e tratamento de
superfície.
Embalagem de segurança
e proteção.

FEATURES

*Author's furniture.
Iconic design made of
architectonic concrete and
other noble materials with high
production quality, handmade
finishing and surface treatment.
Protection and security
packaging.*

APLICAÇÕES

Mobiliário e pavimentos de
exterior, projetados para
espaços urbanos e paisagísticos.

APPLICATIONS

*Outdoor furniture and pavings
designed for urban and
landscape spaces.*

AR PURO

Design Daniel Caramelo



Cadeira Coletiva

Collective Chair

04002

180x69x78 cm ≈ 615 kg

Simplemente Apoiado *Self-Standing*



Cadeira Individual

Individual Chair

04001

60x69x78 cm ≈ 200 kg

Simplemente Apoiado *Self-Standing*



Banco Individual

Individual Bench

04003

60x60x45 cm ≈ 150 kg

Simplemente Apoiado *Self-Standing*



Banco Coletivo A
Collective Bench A
04004
180x60x45 cm ≈ 460 kg
Simplesmente Apoiado *Self-Standing*



Mesa A
Table A
04009
180x60x70 cm ≈ 340 kg
Simplesmente Apoiado *Self-Standing*



Papeleira
Paper Bin
04006
60 L
45x40x100 cm ≈ 150 kg
Fixação de Superfície
Surface Permanent Anchoring

Materiais *Materials*

Betão CS/ES
CS/ES Concrete

Aço Inox ou Aço Metalizado Pintado
Stainless Steel or Painted Metallized Steel

Acabamentos Standard *Standard Finishes*

Liso Pigmentado
Smooth Pigmented



Branco
White



Cinza
Grey

Bujardado Suave
Sandblasted



Branco
White



Cinza
Grey

Outros Acabamentos *Other Finishes*

Ver páginas 234-236 | 224
View pages 234-236 | 224

AR PURO

Design Daniel Caramelo



Banco Coletivo B

Collective Bench B

04005

180x60x45 cm ≈ 285 kg

Simplemente Apoiado *Self-Standing*



Chaise Longue

Chaise Longue

04015

148x60x78 cm ≈ 270 kg

Simplemente Apoiado *Self-Standing*



Mesa B

Table

04010

180x120x70 cm ≈ 640 kg

Simplemente Apoiado *Self-Standing*



Floreira 1000

Planter 1000

04011

100x45x43 cm ≈ 235 kg

Simplemente Apoiado *Self-Standing*



Floreira 1800

Planter 1800

04012

180x45x43 cm ≈ 400 kg

Simplemente Apoiado *Self-Standing*



Floreira Cubo

Planter Cubo

04013

100x100x100 cm ≈ 805 kg

Simplemente Apoiado *Self-Standing*

**Bebedouro***Fountain*

04007

35x58x85 cm ≈ 110 kg

Com Fundação *With Foundation* +15 cmEncastrado Simples *Recessed Setting***Stop Bicicleta***Bicycle Rack*

04016

25x20x78 cm ≈ 105 kg

Com Fundação *With Foundation* +40 cmEncastrado Simples *Recessed Setting***Stop Bicicleta 2***Bicycle Rack 2*

04018

100x11x75 cm ≈ 90 kg

Com Fundação *With Foundation* +20 cmEncastrado Simples *Recessed Setting***Guarda Corpos***Protection Barrier*

04019

120x11x95 cm ≈ 110 kg

Com Fundação *With Foundation* +20 cmEncastrado Simples *Recessed Setting***Dissuasor***Bollard*

04008

25x25x50 cm ≈ 150 kg

Com Fundação *With Foundation* +25 cmEncastrado Simples *Recessed Setting***Materiais** *Materials*Betão CS/ES
*CS/ES Concrete***Acabamentos Standard** *Standard Finishes*Liso Pigmentado
Smooth PigmentedBranco
WhiteCinza
*Grey*Bujardado Suave
SandblastedBranco
WhiteCinza
*Grey***Outros Acabamentos** *Other Finishes*Ver páginas 234-236 | 224
*View pages 234-236 | 224*Aço Inox ou Aço Metalizado Pintado
Stainless Steel or Painted Metallized Steel

AR PURO+

Design Daniel Caramelo

▼ Espessura Reduzida
▲ Reduced Thickness



Cadeira Coletiva

Collective Chair

04402

180x63x76 cm ≈ 425 kg

Fixação de Superfície

Surface Permanent Anchoring



Cadeira Individual

Individual Chair

04401

60x63x76 cm ≈ 130 kg

Fixação de Superfície

Surface Permanent Anchoring



Banco Individual

Individual Bench

04403

60x60x45 cm ≈ 100 kg

Fixação de Superfície

Surface Permanent Anchoring

Materials Materials

Betão UHPC
UHPC Concrete

Acabamentos Standard Standard Finishes

Liso Pigmentado
Smooth Pigmented



Branco
White



Cinza
Grey

Bujardado Suave
Sandblasted



Branco
White



Cinza
Grey

Outros Acabamentos Other Finishes

Ver páginas 230-231 | 224
View pages 230-231 | 224







Banco Coletivo B
Collective Bench B
 04405
 180x60x45 cm ≈ 190 kg
 Fixação de Superfície
Surface Permanent Anchoring



Banco Coletivo B 3000
Collective Bench B 3000
 04420
 300x60x45 cm ≈ 390 kg
 Fixação de Superfície
Surface Permanent Anchoring



Mesa
Table
 04409
 180x60x70 cm ≈ 225 kg
 Fixação de Superfície
Surface Permanent Anchoring



Papeleira
Paper Bin
 04406
 60 L
 40x40x90 cm ≈ 90 kg
 Fixação de Superfície
Surface Permanent Anchoring



Guarda Corpos
Protection Barrier
 04419
 120x11x95 cm ≈ 94 kg
 Com Fundação *With Foundation* +20 cm
 Encastrado Simples *Recessed Setting*



Stop Bicicletas 2
Bicycle Rack 2
 04418
 100x11x75 cm ≈ 77 kg
 Com Fundação *With Foundation* +20 cm
 Encastrado Simples *Recessed Setting*

Materiais *Materials*

Betão UHPC
UHPC Concrete

Acabamentos Standard *Standard Finishes*

Liso Pigmentado
Smooth Pigmented



Branco
White



Cinza
Grey

Bujardado Suave
Sandblasted



Branco
White



Cinza
Grey

Outros Acabamentos *Other Finishes*

Ver páginas 230-231 | 224
View pages 230-231 | 224

Aço Inox ou Aço Metalizado Pintado
Stainless Steel or Painted Metallized Steel

AMOPLAY

Design Pedrita



Parede de Giz Individual

Single Chalk Wall

03015

210x9x118 cm ≈ 920 kg

Com Fundação *With Foundation* +42 cm

Encastrado Simples *Recessed Setting*



Parede de Giz Dupla

Double Chalk Wall

03007

210x18x118 cm ≈ 1835 kg

Com Fundação *With Foundation* +42 cm

Encastrado Simples *Recessed Setting*

**Mesa**

Table

03018

Ø 120x(60/70/80) cm ≈ 515 kg

Com Fundação With Foundation

Encastrado Simples Recessed Setting

**Mesa de Areia**

Sand Table

03008

Ø 120x(60/70/80) cm ≈ 360 kg

Com Fundação With Foundation

Encastrado Simples Recessed Setting

**Mesa de Ping Pong**

Ping Pong Table

03021

274x153x76 cm ≈ 1295 kg

Simplesmente Apoiado Self-Standing

**Mesa de Xadrez**

Chess Table

03017

Ø 120x(60/70/80) cm ≈ 515 kg

Com Fundação With Foundation

Encastrado Simples Recessed Setting

**Mesa de Raquetes**

Racket Table

03020

230x140x86cm ≈ 1045kg

Simplesmente Apoiado Self-Standing

**Mesa de Futebol / Voleibol**

Football / Volleyball Table

03026

300x150x90 cm ≈ 1565 kg

Simplesmente Apoiado Self-Standing

**Materiais Materials**

Betão CS/ES
CS/ES Concrete

Acabamentos Standard Standard Finishes

Liso Pigmentado
Smooth Pigmented

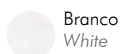

Branco
White



Cinza
Grey



Pintado Cores RAL
Painted RAL Colours

Outros Acabamentos Other Finishes

Ver páginas 234-236
View pages 234-236

AMOPLAY

Design Pedrita



Mesa Alta

High Table

03022

Ø 120x(90/100/110) cm ≈ 720 kg

Com Fundação *With Foundation*

Encastrado Simples *Recessed Setting*



Banco

Bench

03019

Ø 36x(32/42/52) cm ≈ 70 kg

Com Fundação *With Foundation*

Encastrado Simples *Recessed Setting*



Floreira

Planter

03025

Ø 120x(20/30/45) cm ≈ 340 kg

Com Fundação *With Foundation*

Encastrado Simples *Recessed Setting*



Banco XL

XL Bench

03024

Ø 120x(20/30/45) cm ≈ 570 kg

Com Fundação *With Foundation*

Encastrado Simples *Recessed Setting*



Boia 110

Buoy 110

03012

Ø 110x83 cm ≈ 235 kg

Com Fundação *With Foundation* +90 cm

Encastrado Simples *Recessed Setting*



Boia 75

Buoy 75

03013

Ø 75x57 cm ≈ 220 kg

Com Fundação *With Foundation* +66 cm

Encastrado Simples *Recessed Setting*

**Tubo***Pipe*

03009

164x Ø 94 cm ≈ 1125 kg

Simplesmente Apoiado *Self-Standing***Tubo Curva***Curved Pipe*

03010

187x106x Ø 94 cm ≈ 1020kg

Simplesmente Apoiado *Self-Standing***Tubo Y***Y Pipe*

03011

187x162x Ø 94 cm ≈ 1390 kg

Simplesmente Apoiado *Self-Standing***Materiais** *Materials*Betão CS/ES
CS/ES Concrete**Acabamentos Standard** *Standard Finishes*Liso Pigmentado
Smooth PigmentedBranco
WhiteCinza
GreyPintado Cores RAL
Painted RAL Colours**Outros Acabamentos** *Other Finishes*Ver páginas 234-236
View pages 234-236

EXERCISE

Design Gonçalo Silva



**Base Cell***Base Cell*

02101

251x220x12 cm ≈ 1205 kg

Simplesmente Apoiado *Self-Standing*Treino *Workout:*Cardio/ Corpo Total *Cardio/ Full Body***Rubber Cell***Rubber Cell*

02102

251x220x12 cm ≈ 1210 kg

Simplesmente Apoiado *Self-Standing*Treino *Workout:*Abdominal/ Cardio *Core/ Cardio***Green Cell***Green Cell*

02103

251x220x12 cm ≈ 900 kg

Simplesmente Apoiado *Self-Standing*

Vegetação e Sombreamento

Vegetation and Shading**Step Up***Step Up*

02105

185x110x12 cm ≈ 400 kg

Simplesmente Apoiado *Self-Standing*Treino *Workout:*Cardio/ Parte Inferior do Corpo *Cardio/ Lower Body***Step Up 30***Step Up 30*

02106

185x110x42 cm ≈ 1407 kg

Simplesmente Apoiado *Self-Standing*Treino *Workout:*Cardio/ Parte Inferior do Corpo *Cardio/ Lower Body***Step Up 50***Step Up 50*

02107

212x124x62 cm ≈ 2077 kg

Simplesmente Apoiado *Self-Standing*Treino *Workout:*Cardio/ Parte Inferior do Corpo *Cardio/ Lower Body*

RAL 1023

RAL 4010

RAL 5015

RAL 7046

Materiais *Materials*Betão CS/ES
*CS/ES Concrete***Acabamentos Standard** *Standard Finishes*Bujardado Suave
SandblastedCinza
GreyBranco
WhitePintado Cores RAL
*Painted RAL Colours***Outros Acabamentos** *Other Finishes*Ver páginas 234-236
View pages 234-236

EXERCISE

Design Gonçalo Silva



Step Ups Cell

Step Ups Cell

02104

250x220x62 cm ≈ 3884 kg

Simplemente Apoiado *Self-Standing*

Treino *Workout:*

Cardio/ Parte Inferior do Corpo *Cardio/ Lower Body*



Bar 30 Cell

Bar 30 Cell

02108

251x220x42 cm ≈ 1223kg

Simplemente Apoiado *Self-Standing*

Treino *Workout:*

Parte Superior do Corpo *Upper Body*



Bar 40 Cell

Bar 40 Cell

02109

251x220x53 cm ≈ 1228 kg

Simplemente Apoiado *Self-Standing*

Treino *Workout:*

Parte Superior do Corpo/ Parte Inferior do corpo

Upper Body/ Lower Body



Bar 80 Cell

Bar 80 Cell

02110

251x220x92 cm ≈ 1222 kg

Simplemente Apoiado *Self-Standing*

Treino *Workout:*

Parte Superior do Corpo/ Alongamentos

Upper Body/ Stretches



Parallel Bars Cell

Parallel Bars Cell

02111

251x220x135 cm ≈ 1244 kg

Simplemente Apoiado *Self-Standing*

Treino *Workout:*

Parte Superior do Corpo/ Abdominal *Upper Body/ Core*



Incline Bench Cell

Incline Bench Cell

02116

251x220x91 cm ≈ 2133 kg

Simplemente Apoiado *Self-Standing*

Treino *Workout:*

Abdominal *Core*

**Bar 200 Cell***Bar 200 Cell*

02112

251x220x210 cm ≈ 1236 kg

Simplesmente Apoiado *Self-Standing*Treino *Workout:*Parte Superior do Corpo/ Abdominal *Upper Body/ Core***Bar 230 Cell***Bar 230 Cell*

02113

251x220x242 cm ≈ 1238 kg

Simplesmente Apoiado *Self-Standing*Treino *Workout:*Parte Superior do Corpo/ Abdominal *Upper Body/ Core***Stall Bars Cell***Stall Bars Cell*

02114

251x220x242 cm ≈ 1258 kg

Simplesmente Apoiado *Self-Standing*Treino *Workout:*Parte Superior do Corpo/ Alongamentos *Upper Body/ Stretches***Monkey Bars Cell***Monkey Bars Cell*

02115

251x220x242 cm ≈ 1276 kg

Simplesmente Apoiado *Self-Standing*Treino *Workout:*Parte Superior do Corpo *Upper Body***Materiais** *Materials*Betão CS/ES
CS/ES Concrete**Acabamentos Standard** *Standard Finishes*Bujardado Suave
SandblastedCinza
GreyBranco
WhitePintado Cores RAL
Painted RAL Colours**Outros Acabamentos** *Other Finishes*Ver páginas 234-236
View pages 234-236

EXERCISE

Design Gonçalo Silva

UMA NOVA DIMENSÃO DE OUTDOOR FITNESS

Uma linha de outdoor fitness de uma nova dimensão, capaz de transformar a rotina de exercícios ao ar livre. A partir de um módulo hexagonal, inspirado nas células, os equipamentos de ginástica são projetados, distribuídos de maneira estratégica, de forma a fornecer uma experiência de treino completa e eficiente, com opções para todos os níveis de condicionamento físico. Quando as nossas células competem e se adaptam às condições ambientais, elas promovem um equilíbrio vital. Assim como, o nosso corpo se fortalece com o exercício, a habilidade das células em se ajustar é a chave para uma vida ativa e saudável.

PLUG & PLAY

Concebido para que os espaços de exercício, estejam integrados com espaços verdes e com sombreamento natural. De simples implantação, bastando pousar no terreno os módulos de pavimento hexagonal. Com a vantagem de realocação ou reposicionamento futuro. Podem ser dispostos ao longo de um percurso, conjugados ou combinados numa área de exercícios com maior ou menor dimensão. Um produto com a garantia da Amop, sustentável e resiliente, com baixa manutenção.

A NEW DIMENSION OF OUTDOOR FITNESS

An outdoor fitness line with a new dimension, capable of transforming your outdoor exercise routine. Based on a hexagonal module inspired by cells, the gym equipment is designed and strategically distributed to provide a complete and efficient training experience, with options for all fitness levels. When our cells compete and adapt to environmental conditions, they promote a vital balance. Just as our bodies become stronger through exercise, the ability of these cells in adjusting, is the key to an active and healthy life.

PLUG & PLAY

Designed so that exercise areas are integrated with green spaces, with natural shading. The hexagonal flooring modules are easy to install by simply placing them on the ground. The advantage is that they can be relocated or repositioned in the future. They can be laid out along a pathway, joined together or combined in a larger or smaller exercise area. A product with Amop guarantee, sustainable and resilient, with low maintenance.

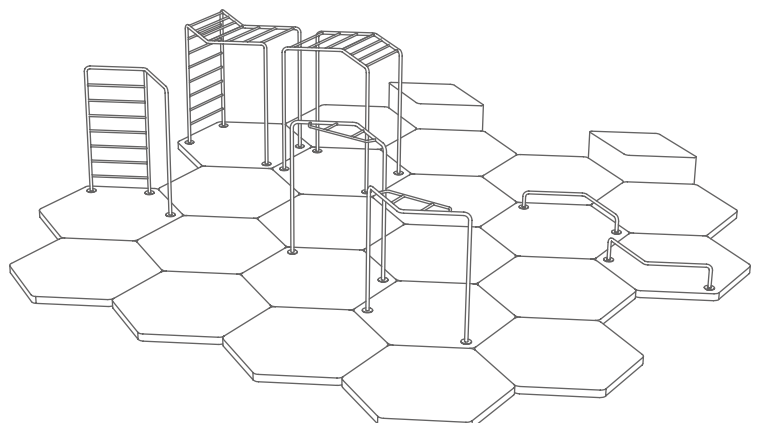
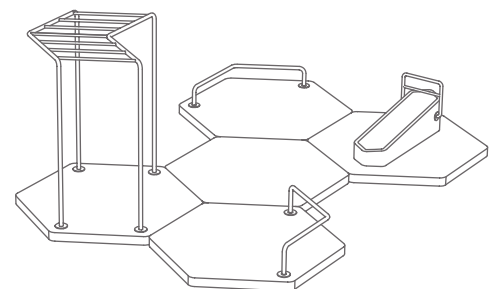
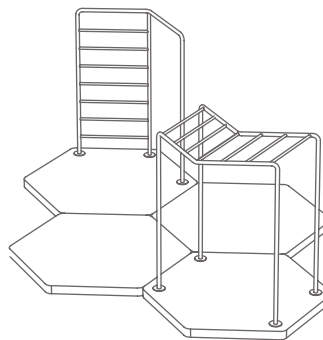
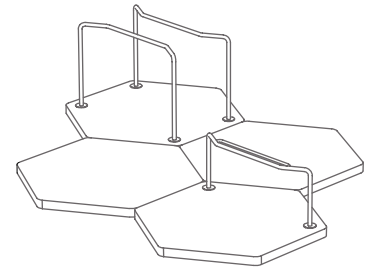
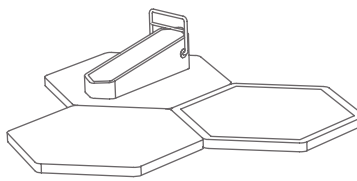
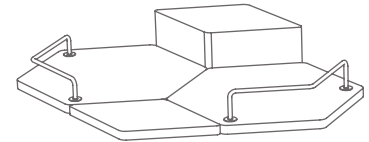
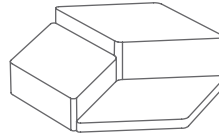
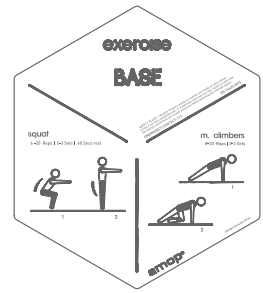

BENAVENTE

Design Joana Brito e Vitor Hugo Matos



Banco 200

Bench 200
32050
200x50x45 cm ≈ 1005 kg
Encastrado Simples *Recessed Setting*
Com Fundação *With Foundation* +26 cm



Banco Convexo R300-30°

Convex Bench R300-30°
32051
181x50x45 cm ≈ 831 kg
Encastrado Simples *Recessed Setting*
Com Fundação *With Foundation* +26 cm



Banco Convexo R50-90°

Convex Bench R50-90°
32052
175x175x45 cm ≈ 1274 kg
Encastrado com Fixação *Anchored Recessed Setting*
Com Fundação *With Foundation* +26 cm

Materiais *Materials*

Betão CS/ES
CS/ES Concrete

Acabamentos Standard *Standard Finishes*

Liso Pigmentado
Smooth Pigmented



Branco
White



Cinza
Grey

Bujardado Suave
Sandblasted



Branco
White



Cinza
Grey

Outros Acabamentos *Other Finishes*

RE-CYCLE

Ver páginas 232-236
View pages 232-236



Pintado Cores RAL
Painted RAL Colours

Add-ons

Kit Relax System | Kit LED

LANDSCAPES

Design Joana Coutinho



Stone With Topper XL

Stone With Topper XL
02002
Ø 200x57 cm ≈ 2020 kg
Simplesmente Apoiado *Self-Standing*



Stone With Topper

Stone With Topper
02001
Ø 150x53 cm ≈ 1220 kg
Simplesmente Apoiado *Self-Standing*



Topper

Topper
02005
Ø 70x14 cm ≈ 90 kg
Simplesmente Apoiado *Self-Standing*

**Topper XL***Topper XL*

02006

Ø 93x19 cm ≈ 215 kg

Simplesmente Apoiado *Self-Standing***Stone B***Stone B*

02010

Ø 150x43 cm ≈ 1130 kg

Simplesmente Apoiado *Self-Standing***Stone B XL***Stone B XL*

02011

Ø 200x43cm ≈ 1800 kg

Simplesmente Apoiado *Self-Standing***Materiais Materials**Betão CS/ES
CS/ES Concrete**Acabamentos Standard Standard Finishes**Liso Pigmentado
Smooth PigmentedBranco
WhiteCinza
GreyBujardado Suave
SandblastedBranco
WhiteCinza
Grey**Outros Acabamentos Other Finishes****RE-CYCLE**Ver páginas 232-236
View pages 232-236Pintado Cores RAL
Painted RAL Colours

LANDSCAPES

Design Joana Coutinho



Stone BC
Stone BC
02014
Ø 150x46 cm ≈ 1730 kg
Simplesmente Apoiado *Self-Standing*



Stone BC XXL
Stone BC XXL
02015
Ø 230x46 cm ≈ 4215 kg
Simplesmente Apoiado *Self-Standing*

**Flower Stone XL C***Flower Stone XL C*

02008

Ø 200x43 cm ≈ 1770 kg

Simplesmente Apoiado *Self-Standing***Flower Stone XL E***Flower Stone XL E*

02009

Ø 200x24 cm ≈ 1275 kg

Simplesmente Apoiado *Self-Standing***Fire Place XL***Fire Place XL*

02016

Ø 200x43 cm ≈ 1780 kg

Simplesmente Apoiado *Self-Standing***Storm***Storm*

02003

Ø 200x118 cm ≈ 2050 kg

Simplesmente Apoiado *Self-Standing***Storm Perch***Storm Perch*

02012

Ø 97x87 cm ≈ 465 kg

Simplesmente Apoiado *Self-Standing***Pebble***Pebble*

02013

Ø 65x46 cm ≈ 280 kg

Simplesmente Apoiado *Self-Standing***Materiais Materials**Betão CS/ES
CS/ES Concrete**Acabamentos Standard Standard Finishes**Liso Pigmentado
Smooth PigmentedBranco
WhiteCinza
GreyBujardado Suave
SandblastedBranco
WhiteCinza
Grey**Outros Acabamentos Other Finishes**Pintado Cores RAL
Painted RAL Colours**RE-CYCLE**Ver páginas 232-236
View pages 232-236

CELL FORMS

Design Atelier Lopes da Costa / Tiago Amaral



**Cell II**

Cell II

01062

314x251x45 cm ≈ 4830 kg

Simplesmente Apoiado Self-Standing

**Cell I**

Cell I

01061

247x245x45 cm ≈ 3880 kg

Simplesmente Apoiado Self-Standing

**Cell III**

Cell III

01063

368x241x45cm ≈ 6130 kg

Simplesmente Apoiado Self-Standing

Materiais MaterialsBetão CS/ES
CS/ES Concrete**Acabamentos Standard** Standard FinishesLiso Pigmentado
Smooth PigmentedBranco
WhiteCinza
GreyPintado Cores RAL
Painted RAL Colours**Outros Acabamentos** Other FinishesVer páginas 234-236
View pages 234-236

MATADI

Design Landplan



**Banco I***Bench I*

24001

136x79x45 cm ≈ 790 kg

Simplesmente Apoiado *Self-Standing***Banco II***Bench II*

24002

170x92x45 cm ≈ 1150 kg

Simplesmente Apoiado *Self-Standing***Banco III***Bench III*

24003

200x103x45 cm ≈ 1530 kg

Simplesmente Apoiado *Self-Standing***Banco IV***Bench IV*

24004

144x90x87cm ≈ 1175kg

Simplesmente Apoiado *Self-Standing***Materiais Materials**Betão CS/ES
CS/ES Concrete**Acabamentos Standard Standard Finishes**Liso Pigmentado
Smooth PigmentedBranco
WhiteCinza
GreyBujardado Suave
SandblastedBranco
WhiteCinza
Grey**Outros Acabamentos Other Finishes****RE-CYCLE**Ver páginas 232-236
View pages 232-236Pintado Cores RAL
Painted RAL Colours

DNA

Design Amop



Banco Coletivo 250
Collective Bench 250
 01370
 250x60x46 cm ≈ 1535 kg
 Simplesmente Apoiado *Self-Standing*



Banco Coletivo Y
Collective Bench Y
 01371
 238x206x46 cm ≈ 2100 kg
 Simplesmente Apoiado *Self-Standing*

Materials *Materials*

Betão CS/ES
CS/ES Concrete

Acabamentos Standard *Standard Finishes*

Bujardado Suave
Sandblasted



Branco
White



Cinza
Grey

Outros Acabamentos *Other Finishes*

RE-CYCLE

Ver páginas 232-236
View pages 232-236

Add-ons

Kit Relax System

LIVRE

Design Laura Roldão Costa



Mesa Alta

High Table

25003

67x57x110 cm ≈ 695 kg

Com Fundação With Foundation +30 cm

Encastrado com Fixação Anchored Recessed Setting



Mesa

Table

25002

96x85x75 cm ≈ 705 kg

Com Fundação With Foundation +30 cm

Encastrado com Fixação Anchored Recessed Setting



Banco

Bench

25001

48x44x43 cm ≈ 175 kg

Com Fundação With Foundation +20 cm

Encastrado com Fixação Anchored Recessed Setting

Materiais Materials

Betão CS/ES
CS/ES Concrete

Acabamentos Standard Standard Finishes

Liso Pigmentado
Smooth Pigmented



Branco
White



Cinza
Grey

Bujardado Suave
Sandblasted



Branco
White



Cinza
Grey

Outros Acabamentos Other Finishes

RE-CYCLE

Ver páginas 232-236
View pages 232-236



Pintado Cores RAL
Painted RAL Colours

DOLMA

Design Omos



**Banco S***Bench S*

01202

86x84x45 cm ≈ 415 kg

Simplesmente Apoiado *Self-Standing***Floreira S***Planter S*

01200

83x74x61 cm ≈ 240 kg

Simplesmente Apoiado *Self-Standing***Floreira XL***Planter XL*

01201

121x116x130 cm ≈ 880 kg

Simplesmente Apoiado *Self-Standing***Banco XL***Bench XL*

01203

212x144x45 cm ≈ 1860 kg

Simplesmente Apoiado *Self-Standing***Materiais** *Materials*Betão CS/ES
*CS/ES Concrete***Acabamentos Standard** *Standard Finishes*Liso Pigmentado
Smooth PigmentedBranco
WhiteCinza
*Grey*Desbastado
HonedPedra Lioz
Lioz StoneGranito Azul
*Blue Granite***Outros Acabamentos** *Other Finishes*Ver páginas 234-236 | 224
*View pages 234-236 | 224*Aço Inox ou Aço Metalizado Pintado
Stainless Steel or Painted Metallized Steel

MODO

Design Laura Roldão Costa



**Banco S***Bench S*

01116

180x70x45 cm ≈ 725 kg

Simplesmente Apoiado *Self-Standing***Banco M***Bench M*

01117

220x86x45 cm ≈ 1050 kg

Simplesmente Apoiado *Self-Standing***Floreira S***Planter S*

01143

180x70x45 cm ≈ 520 kg

Simplesmente Apoiado *Self-Standing***Mesa***Table*

01144

240x106x78 cm ≈ 330 kg

Aparafusamento de Superfície *Surface Bolted Anchoring***Banco S com Encosto***Bench S with Backrest*

01182

180x70x81 cm ≈ 760 kg

Simplesmente Apoiado *Self-Standing***Banco M com Encosto***Bench M with Backrest*

01183

220x86x81 cm ≈ 1080 kg

Simplesmente Apoiado *Self-Standing***Materiais Materials Acabamentos Standard Standard Finishes**Betão CS/ES
*CS/ES Concrete*Liso Pigmentado
Smooth PigmentedBranco
WhiteCinza
*Grey*Bujardado
Shot BlastedPedra Lioz
Lioz StoneGranito Azul
*Blue Granite***Outros Acabamentos Other Finishes****RE-CYCLE**Ver páginas 232-236 | 224
*View pages 232-236 | 224*Aço Metalizado Pintado
Painted Metallized Steel

AMENO

Design Daniel Caramelo



Banco L
 Bench L
 01801
 186x118x43 cm ≈ 1685 kg
 Simplesmente Apoiado *Self-Standing*



Floreira L
 Planter L
 01802
 186x118x43 cm ≈ 725 kg
 Simplesmente Apoiado *Self-Standing*

**Banco Floreira XL***Planter Bench XL*

01805

334x142x43 cm ≈ 3275 kg

Simplesmente Apoiado *Self-Standing***Banco XL***Bench XL*

01804

334x142x43 cm ≈ 3800 kg

Simplesmente Apoiado *Self-Standing***Betão Desbastado***Honed Concrete***Betão Bujardado***Sandblasted Concrete***Banco XL com Encosto***Bench XL With Backrest*

01806

334x142x73 cm ≈ 4325 kg

Simplesmente Apoiado *Self-Standing***Materiais** *Materials*Betão CS/ES
*CS/ES Concrete*Aço Metalizado Pintado
*Painted Metallized Steel***Acabamentos Standard** *Standard Finishes*Desbastado e Bujardado
Honed and Shot blastedPedra Lioz
Lioz StoneGranito Azul
Blue GraniteAntracite Micro Texturado
Micro Textured AnthracitePintado Cores RAL
*Painted RAL Colours***Outros Acabamentos** *Other Finishes*Ver páginas 234-236 | 224
View pages 234-236 | 224

GRIP

Design Antonio Mastrorilli - Gibillero Design



**Banco 180**

Bench 180
32020
180x46x55 cm ≈ 80 kg
Aparafusamento de Superfície *Surface Bolted Anchoring*

**Cadeira 180**

Chair 180
32021
180x55x81 cm ≈ 91 kg
Aparafusamento de Superfície *Surface Bolted Anchoring*

**Floreira 40L**

Planter 40L
32024
52x50x61 cm ≈ 68 kg
Aparafusamento de Superfície *Surface Bolted Anchoring*

**Papeleira 80L**

Paper Bin 80L
32022
52x50x91 cm ≈ 97 kg
Aparafusamento de Superfície *Surface Bolted Anchoring*

**Papeleira 80L com Tampa**

Paper Bin 80L with Lid
32023
52x50x110 cm ≈ 115 kg
Aparafusamento de Superfície *Surface Bolted Anchoring*

Materiais *Materials*

Aço Metalizado Pintado
Painted Metallized Steel

Acabamentos Standard *Standard Finishes*

Antracite Micro Texturado
Micro Textured Anthracite



Pintado Cores RAL
Painted RAL Colours

Outros Acabamentos *Other Finishes*

Ver páginas 224
View pages 224

MODULAR

Design Carlos Manuel Santos





Mesa
Table
08004
200x70x80 cm ≈ 595 kg
Simplesmente Apoiado *Self-Standing*



Banco R
Bench R
08001
200x50x45 cm ≈ 335 kg
Simplesmente Apoiado *Self-Standing*



Banco R Individual
Individual Bench R
08005
50x50x45 cm ≈ 150 kg
Simplesmente Apoiado *Self-Standing*



Banco C R550 - 23°
Bench C R550 - 23°
08002
215x50x45 cm ≈ 345 kg
Simplesmente Apoiado *Self-Standing*



Stop Bicicleta R550 - 23°
Bicycle Rack R550 - 23°
08003
215x50x57 cm ≈ 345 kg
Simplesmente Apoiado *Self-Standing*

Materials *Materials*

Betão CS/ES
CS/ES Concrete

Aço Inox ou Aço Metalizado Pintado
Stainless Steel or Painted Metallized Steel

Acabamentos Standard *Standard Finishes*

Bujardado
Shot Blasted



Pedra Lioz
Lioz Stone



Granito Azul
Blue Granite

Outros Acabamentos *Other Finishes*

Ver páginas 234-236 | 224
View pages 234-236 | 224

Add-ons

Kit Relax System

MODULAR

Design Carlos Manuel Santos



Banco Retilíneo Orieva M
 Straight Orieva M Bench
 01093
 240x80x45 cm ≈ 615 kg
 Simplesmente Apoiado *Self-Standing*



Banco Retilíneo Orieva C
 Straight Orieva C Bench
 01094
 240x80x45 cm ≈ 615 kg
 Simplesmente Apoiado *Self-Standing*



Caldeira S
Tree Surround S
01188
160x160x30 cm ≈ 840 kg
Encastrado Simples *Recessed Setting*



Caldeira DaFoz 1
DaFoz 1 Tree Surround
01023
100x100x10 cm (R39) ≈ 124 kg
Encastrado Simples *Recessed Setting*



Caldeira DaFoz 2
DaFoz 2 Tree Surround
01024
100x100x10 cm (R39) ≈ 124 kg
Encastrado Simples *Recessed Setting*



Caldeira L
Tree Surround L
01189
210x210x30 cm ≈ 1140 kg
Encastrado Simples *Recessed Setting*



Floreira Retangular 100
Rectangular Planter 100
01018
100x50x50 cm ≈ 340 kg
Simplesmente Apoiado *Self-Standing*



Bebedouro Ypsilon
Fountain Ypsilon
01016
35x35x105 cm ≈ 190 kg
Encastrado Simples *Recessed Setting*



Floreira Quadrada 50
Square Planter 50
01034
50x50x50 cm ≈ 210 kg
Simplesmente Apoiado *Self-Standing*



Floreira Retangular 175
Rectangular Planter 175
01019
175x50x50 cm ≈ 580 kg
Simplesmente Apoiado *Self-Standing*





Floreira Quadrada 115
Square Planter 115
01020
115x115x90 cm ≈ 1500 kg
Simplesmente Apoiado *Self-Standing*

Materials *Materials*

Betão CS/ES
CS/ES Concrete

Aço Inox ou Aço Metalizado Pintado
Stainless Steel or Painted Metallized Steel

Acabamentos Standard *Standard Finishes*

Bujardado  Pedra Lioz  Granito Azul 

Outros Acabamentos *Other Finishes*

Ver páginas 234-236 | 224
View pages 234-236 | 224

Add-ons

Kit Relax System

BASICS

Amop



Dissuasor Globo 30
 Globe Bollard 30
 01008
 Ø 30 cm ≈ 90 kg
 Encastrado Rígido
 Concrete Base Setting



Dissuasor Globo 40
 Globe Bollard 40
 01007
 Ø 40 cm ≈ 90 kg
 Encastrado Rígido
 Concrete Base Setting



Dissuasor Globo 80
 Globe Bollard 80
 01006
 Ø 80 cm ≈ 700 kg
 Encastrado Rígido
 Concrete Base Setting



Dissuasor Globo 115
 Globe Bollard 115
 01186
 Ø 115 cm ≈ 1990 kg
 Encastrado Rígido
 Concrete Base Setting



Cubo 40
Cube 40
01901
40x40x42 cm ≈ 165 kg
Fixação de Superfície
Surface Permanent Anchoring



Cilindro 48
Cylinder 48
01902
Ø 40x48 cm ≈ 150 kg
Fixação de Superfície
Surface Permanent Anchoring



Cilindro 75
Cylinder 75
01903
Ø 45x75 cm ≈ 290 kg
Fixação de Superfície
Surface Permanent Anchoring



Cone
Cone
01129
Ø 68x100 cm ≈ 478 kg
Fixação de Superfície
Surface Permanent Anchoring

Materiais Materials

Betão CS/ES
CS/ES Concrete

Acabamentos Standard Standard Finishes

Bujardado Suave
Sandblasted



Branco
White



Cinza
Grey

Bujardado
Shot Blasted



Pedra Lioz
Lioz Stone



Granito Azul
Blue Granite



Liso Pintado Cores RAL
Smooth Painted RAL Colours

Outros Acabamentos Other Finishes

RE-CYCLE

Ver páginas 232-236
View pages 232-236

BASICS

Amop



Dissuasor Baixo Bossa

Bossa Low Bollard

01220

29x21x23 cm ≈ 23 kg

Com Fundação *With Foundation 6 cm*

Encastrado com Fixação *Anchored Recessed Setting*

Design Gonçalo Campos



Dissuasor Alto Bossa

Bossa High Bollard

01221

38x28x31 cm ≈ 53 kg

Com Fundação *With Foundation 6 cm*

Encastrado com Fixação *Anchored Recessed Setting*

Design Gonçalo Campos



Monobanco Donk

Donk Single Bench

01010

Ø 50x45 cm ≈ 145 kg

Fixação de Superfície *Surface Permanent Anchoring*

Design Imaginarq



Donk Tribanco

Donk Triple Bench

01009

150x50x45 cm ≈ 565 kg

Fixação de Superfície *Surface Permanent Anchoring*

Design Imaginarq



Banco Caldeira S R800 - 180°

Treesurround Bench S R800 - 180°

01193

160x40x42 cm ≈ 195 kg

Aparafusamento de Superfície *Surface Bolted Anchoring*



Banco Caldeira SW R800 - 180°

Treesurround Bench SW R800 - 180°

01329

160x40x45 cm ≈ 210 kg

Aparafusamento de Superfície *Surface Bolted Anchoring*

**Caldeira Green S***Green S Treesurround*

01051

Ø 60x12 cm ≈ 184 kg

Encastrado Simples *Recessed Setting***Caldeira Green L***Green L Treesurround*

01052

160x160x12 cm ≈ 416 kg

Encastrado Simples *Recessed Setting***Caldeira Green S+L***Green S+L Treesurround*

01050

160x160x12 cm ≈ 600 kg

Encastrado Simples *Recessed Setting***Caldeira Marselha***Marselha Treesurround*

01187

200x200x30 cm ≈ 1680 kg

Encastrado Simples *Recessed Setting***Banco Caldeira I R135 - 180°***Treesurround Bench I R135 - 180°*

01192

269x60x40 cm ≈ 1305 kg

Simplesmente Apoiado *Self-Standing***Materiais Materials Acabamentos Standard Standard Finishes**Betão CS/ES
CS/ES ConcreteBujardado Suave
SandblastedBranco
WhiteCinza
GreyBujardado
Shot BlastedPedra Lioz
Lioz StoneGranito Azul
Blue Granite**RE-CYCLE**Ver páginas 232-236 | 224
View pages 232-236 | 224Madeira Tropical
Tropical WoodAço Metalizado Pintado
Painted Metallized SteelAntracite Micro Texturado
Micro Textured AnthracitePintado Cores RAL
Painted RAL Colours

BASICS

Amop



Floreira Esplanada

Terrace Planter

01124

150x40x52 cm ≈ 525 kg

Simplemente Apoiado *Self-Standing*

Fixação de Superfície *Surface Permanent Anchoring*



Floreira Esplanada 1VT10

Terrace Planter 1VT10

01095

150x42x152 cm ≈ 585 kg

Simplemente Apoiado *Self-Standing*

Fixação de Superfície *Surface Permanent Anchoring*



Floreira Cubo Model I 60

Cube Planter Model I 60

01905

60x60x45 cm ≈ 40 kg

Simplemente Apoiado *Self-Standing*

Fixação de Superfície *Surface Permanent Anchoring*



Floreira Cubo Model I 240

Cube Planter Model I 240

01906

240x60x45 cm ≈ 95 kg

Simplemente Apoiado *Self-Standing*

Fixação de Superfície *Surface Permanent Anchoring*



Banco Maciço Individual

Individual Massive Bench

01002

60x60x45 cm ≈ 405kg

Simplemente Apoiado *Self-Standing*



Banco Maciço Coletivo

Collective Massive Bench

01001

240x60x45 cm ≈ 890kg

Simplemente Apoiado *Self-Standing*

Materials Materials Acabamentos Standard Standard Finishes

Betão CS/ES
CS/ES Concrete

Bujardado Suave
Sandblasted



Branco
White



Cinza
Grey



Bujardado
Shot Blasted



Pedra Lioz
Lioz Stone



Granito Azul
Blue Granite



Madeira Tropical
Tropical Wood

Aço Metalizado Pintado
Painted Metallized Steel



Antracite Micro Texturado
Micro Textured Anthracite



Pintado Cores RAL
Painted RAL Colours

Outros Acabamentos Other Finishes

RE-CYCLE

Ver páginas 232-236 | 224
View pages 232-236 | 224

Add-ons

Kit Relax System | Kit LED

BASICS

Amop

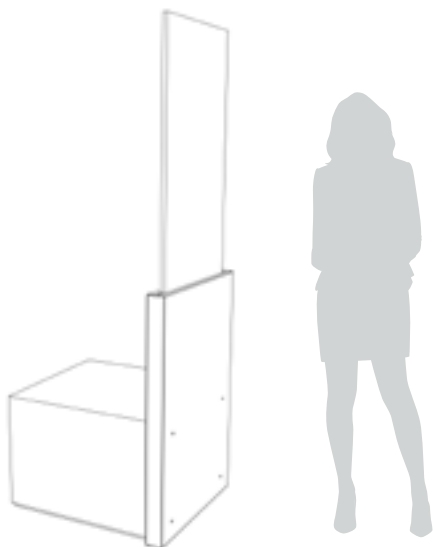

Área útil de comunicação 50x90 cm
 Standard: Vinil Impresso
 Braille sob consulta
 Useful Area 50x90 cm
 Standard: Printed Vinyl
 Braille on request



Totem Model I A

Totem Model I A
 01909
 60x6,5x180 cm ≈ 40 kg
 Aparafusamento de Superfície - Horizontal
 Surface Bolted Anchoring - Horizontal

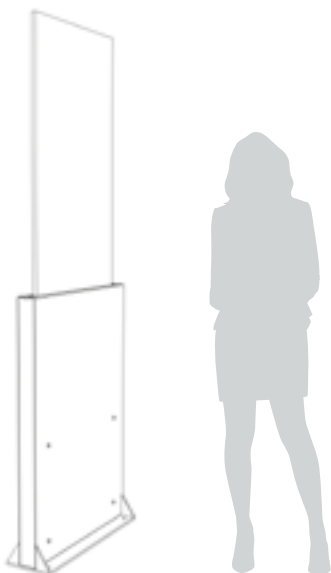

Área útil de comunicação 50x90 cm
 Standard: Vinil Impresso
 Braille sob consulta
 Useful Area 50x90 cm
 Standard: Printed Vinyl
 Braille on request



Totem Model I B

Totem Model I B
 01910
 60x17x181 cm ≈ 50 kg
 Aparafusamento de Superfície - Vertical
 Surface Bolted Anchoring - Vertical

Materials Materials

Aço Metalizado Pintado
 Painted Metallized Steel

Acabamentos Standard Standard Finishes



Antracite Micro Texturado
 Micro Textured Antracite



Pintado Cores RAL
 Painted RAL Colours

Outros Acabamentos Other Finishes

Ver páginas 224
 View pages 224

Área útil 58x12 cm
Useful Area 58x12 cm



Área útil 59x172 cm
Standard: Vinil Impresso
Braille sob consulta
Useful Area 59x172 cm
Standard: Printed Vinyl
Braille on request

Totem Almodôvar

Totem Almodôvar
01128

100x75x262 cm ≈ 1040 kg
Encastrado Simples Recessed Setting
Design Inplenitus



Contentores de Separação de Resíduos 3x120 L

Waste Separation Containers 3x120 L
Cores: Amarelo, Verde, Azul
Colors: Yellow, Gree, Blue



Estação de Serviço Autocaravanismo

Motor Caravanning Service Station
01118
290x110x180 cm ≈ 4650 kg
Encastrado Simples Recessed Setting
Design Rafael Fernandes

Materials Materials

Betão CS/ES
CS/ES Concrete

Acabamentos Standard Standard Finishes

Liso Pigmentado
Smooth Pigmented



Branco
White



Cinza
Grey



Pintado Cores RAL
Painted RAL Colours

Outros Acabamentos Other Finishes

RE-CYCLE

Ver páginas 232-236 | 224
View pages 232-236 | 224

BASICS

Amop



Módulo Anfiteatro 120
 Amphitheater Module 120
 01907
 120x50x45 cm ≈ 875 kg
 Com Fundação With Foundation 20 cm
 Encastrado Simples Recessed Setting



Módulo Anfiteatro 200
 Amphitheater Module 200
 01911
 200x50x45 cm ≈ 1465 kg
 Com Fundação With Foundation 20 cm
 Encastrado Simples Recessed Setting



Módulo Anfiteatro 300
 Amphitheater Module 300
 01912
 300x50x45 cm ≈ 2200 kg
 Com Fundação With Foundation 20 cm
 Encastrado Simples Recessed Setting

Materials Materials

Betão CS/ES
 CS/ES Concrete

Acabamentos Standard Standard Finishes

Bujardado Suave
 Sandblasted



Branco
 White



Cinza
 Grey

Bujardado
 Shot Blasted



Pedra Lioz
 Lioz Stone



Granito Azul
 Blue Granite

Outros Acabamentos Other Finishes

RE-CYCLE

Ver páginas 232-236
 View pages 232-236

Add-ons

Kit Relax System



Stop Bicicletas Stadium

Stop Bicycle Stadium

01003

200x60x51 cm ≈ 1100 kg

Simplemente Apoiado *Self-Standing*

Design Lopes da Costa



Stop Bicicletas Stadium Duplo

Double Stop Bicycle Stadium

01038

200x60x51 cm ≈ 1070 kg

Simplemente Apoiado *Self-Standing*

Design Lopes da Costa

Materials Materials

Betão CS/ES
CS/ES Concrete

Bujardado Suave
Sandblasted



Branco
White



Cinza
Grey

Bujardado
Shot Blasted



Pedra Lioz
Lioz Stone



Granito Azul
Blue Granite

Outros Acabamentos Other Finishes



Ver páginas 232-236 | 224
View pages 232-236 | 224

Aço Inox
Stainless Steel

BASICS

Amop

Pérgulas
Pergolas



Pérgula Retilínea I

Straight Pergola I

01104

470x350x285 cm ≈ 4570 kg

Chumbadouro de Superfície *Surface Platform Anchoring*



Pérgula Retilínea II

Straight Pergola II

01195

470x350x285 cm ≈ 4570 kg

Chumbadouro de Superfície *Surface Platform Anchoring*
Cabo Aço Inox Ø 5 mm *Stainless Steel Cable Ø 5 mm*



Pérgula Curva I

Curve Pergola I

01103

644x386x270 cm ≈ 4700 kg

Chumbadouro de Superfície *Surface Platform Anchoring*



Pérgula Curva II

Curve Pergola II

01196

644x386x270 cm ≈ 4700 kg

Chumbadouro de Superfície *Surface Platform Anchoring*
Cabo Aço Inox Ø 5 mm *Stainless Steel Cable Ø 5 mm*

Materials *Materials*

Betão CS/ES
CS/ES Concrete

Aço Inox
Stainless Steel

Acabamentos Standard *Standard Finishes*

Bujardado Suave
Sandblasted



Branco
White



Cinza
Grey

Bujardado
Shot Blasted



Pedra Lioz
Lioz Stone



Granito Azul
Blue Granite

Outros Acabamentos *Other Finishes*

RE-CYCLE

Ver páginas 232-236
View pages 232-236



Banco Caldeira R150-90
Treesurround Bench R150-90
 01908
 212x50x50 cm ≈ 980 kg
 Simplesmente Apoiado *Self-Standing*

Materials Materials

Betão CS/ES
CS/ES Concrete

Bujardado Suave
Sandblasted



Branco
White



Cinza
Grey

Bujardado
Shot Blasted



Pedra Lioz
Lioz Stone



Granito Azul
Blue Granite

Outros Acabamentos *Other Finishes*



Ver páginas 232-236 | 224
View pages 232-236 | 224

Aço Corten ou Aço Metalizado Pintado
Corten Steel or Painted Metallized Steel

R-LIGHT

Design Rafael Fernandes

▼ Espessura Reduzida
▲ Reduced Thickness



Mesa
Table
23005
200x80x80 cm ≈ 380 kg
Fixação de Superfície
Surface Permanent Anchoring



Banco Coletivo
Collective Bench
23003
200x50x45 cm ≈ 190 kg
Fixação de Superfície
Surface Permanent Anchoring



Banco Individual
Individual Bench
23001
50x50x45 cm ≈ 60 kg
Fixação de Superfície
Surface Permanent Anchoring

**Floreira Quadrada Alta***High Square Planter*

23009

45x45x100 cm ≈ 200 kg

Simplesmente Apoiado *Self-Standing***Papeleira Quadrada Alta***High Square Paperbin*

23013

90 L

45x45x100 cm ≈ 200 kg

Simplesmente Apoiado *Self-Standing***Papeleira Cinzeiro***Paperbin Ashtray*

23014

90 L + 0,6 L

45x45x100 cm ≈ 200 kg

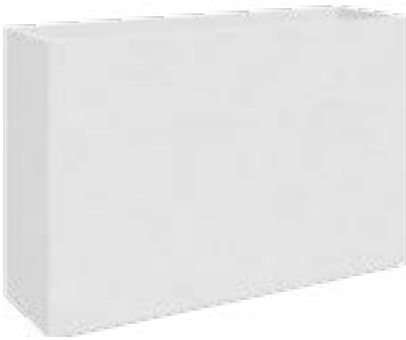
Simplesmente Apoiado *Self-Standing***Floreira Retangular Alta***High Rectangular Planter*

23010

150x45x100 cm ≈ 520 kg

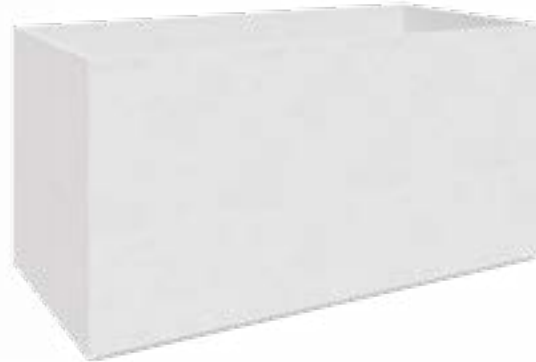
Simplesmente Apoiado *Self-Standing***Floreira Retangular Grande***Large Rectangular Planter*

23011

200x100x100 cm ≈ 1000 kg

Simplesmente Apoiado *Self-Standing***Floreira Quadrada Pequena***Small Square Planter*

23008

50x45x45 cm ≈ 85 kg

Simplesmente Apoiado *Self-Standing***Floreira Retangular***Rectangular Planter*

23012

150x45x45 cm ≈ 230 kg

Simplesmente Apoiado *Self-Standing***Floreira Quadrada Grande***Large Square Planter*

23007

110x110x110 cm ≈ 845 kg

Simplesmente Apoiado *Self-Standing***Materiais Materials**Betão UHPC
UHPC Concrete**Acabamentos Standard Standard Finishes**Liso Pigmentado
Smooth PigmentedBranco
WhiteCinza
GreyBujardado Suave
SandblastedBranco
WhiteCinza
Grey**Outros Acabamentos Other Finishes**Ver páginas 230-231 | 224
View pages 230-231 | 224Aço Inox ou Aço Metalizado Pintado
Stainless Steel or Painted Metallized Steel



E'LEVE

Design Florindo Belo Marques



Mega-Lajetas
Mega-Paving Flags
12001
50x50x6 cm ≈ 150 kg/m²
PRIVATE



Mega-Lajetas
Mega-Paving Flags
12003
100x50x6 cm ≈ 150 kg/m²
PRIVATE



Banco 300
Bench 300
01127
300x50x50 cm ≈ 350 kg
Encastrado com fixação *Anchored Recessed Setting*

Materials Materials

Betão CS/ES
CS/ES Concrete

Acabamentos Standard Standard Finishes

Liso Pigmentado
Smooth Pigmented



Branco
White



Cinza
Grey

Bujardado
Shot Blasted



Pedra Lioz
Lioz Stone



Granito Azul
Blue Granite

Outros Acabamentos Other Finishes

Ver páginas 234-236
View pages 234-236

SOCIAL PLAY

Design Laura Roldão Costa e Sérgio Pinto



2 Elementos

2 Elements

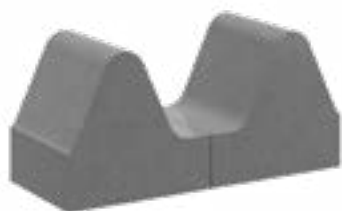

Solução 2C2

2C2 Solution

01309

268x100x130 cm ≈ 5800 kg

Com Fundação *With Foundation* +10 cm

Encastrado Simples *Recessed Setting*

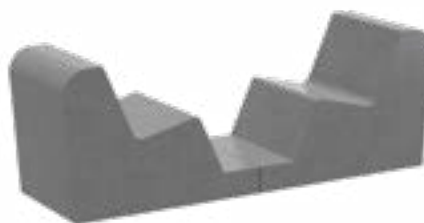

Solução 2C1

2C1 Solution

01308

366x100x129 cm ≈ 6600 kg

Com Fundação *With Foundation* +10 cm

Encastrado Simples *Recessed Setting*

4 Elementos

4 Elements

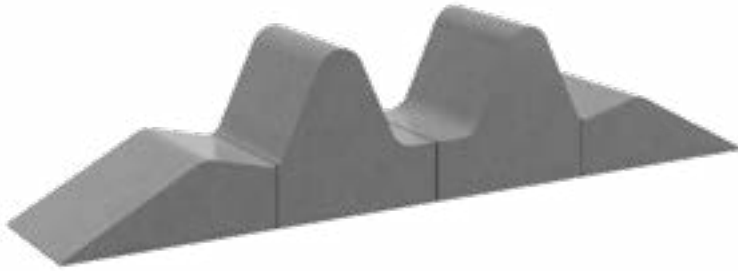

Solução 4C1

4C1 Solution

01305

582x100x130 cm ≈ 9340 kg

Com Fundação *With Foundation* +10 cm

Encastrado Simples *Recessed Setting*

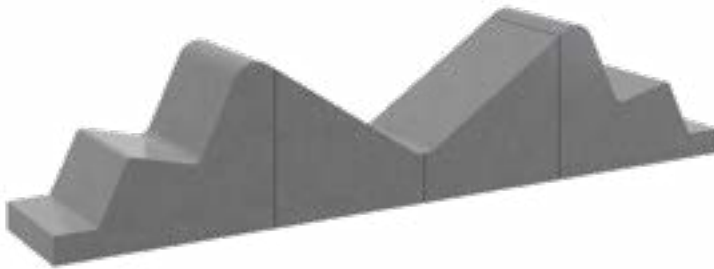

Solução 4C2

4C2 Solution

01306

642x100x140 cm ≈ 13160 kg

Com Fundação *With Foundation* +10 cm

Encastrado Simples *Recessed Setting*

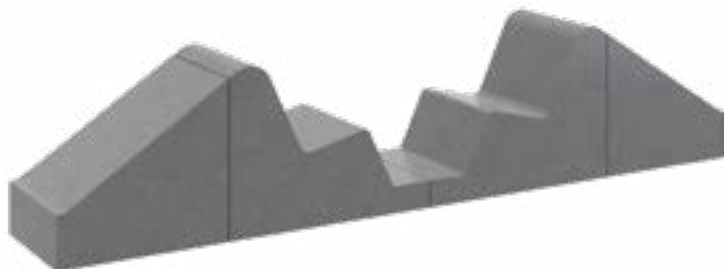

Solução 4C3

4C3 Solution

01307

642x100x140 cm ≈ 13160 kg

Com Fundação *With Foundation* +10 cm

Encastrado Simples *Recessed Setting*

Materials Materials

Betão CS/ES
CS/ES Concrete

Acabamentos Standard Standard Finishes

Liso Pigmentado
Smooth Pigmented



Branco
White



Cinza
Grey



Pintado Cores RAL
Painted RAL Colours

Outros Acabamentos Other Finishes

RE-CYCLE

Ver páginas 232-236
View pages 232-236

SOCIAL PLAY

Design Laura Roldão Costa e Sérgio Pinto

6 Elementos

6 Elements



Solução 6C2

6C2 Solution

01304

924x100x130 cm ≈ 13710 kg

Com Fundação *With Foundation* +10 cm

Encastrado Simples *Recessed Setting*



Solução 6C1

6C1 Solution

01303

1008x100x140 cm ≈ 19760 kg

Com Fundação *With Foundation* +10 cm

Encastrado Simples *Recessed Setting*

8 Elementos

8 Elements



Solução 8C2

8C2 Solution

01302

1118x100x140 cm ≈ 20320 kg

Com Fundação *With Foundation* +10 cm

Encastrado Simples *Recessed Setting*

Funções Sociais

Social Functions

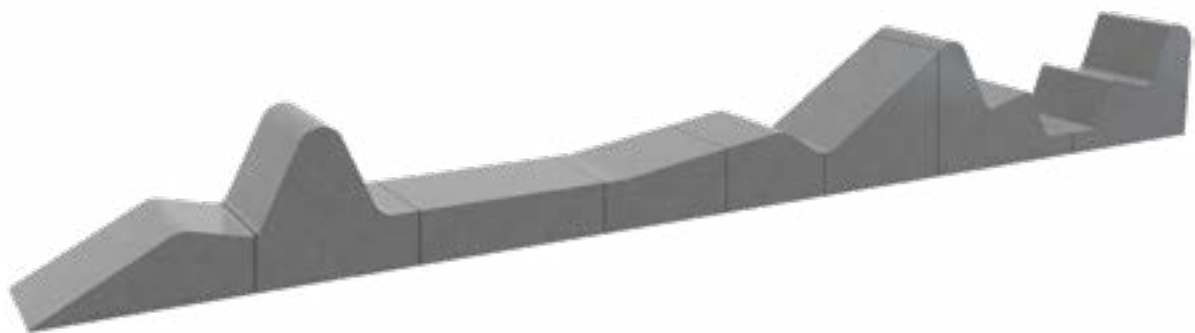
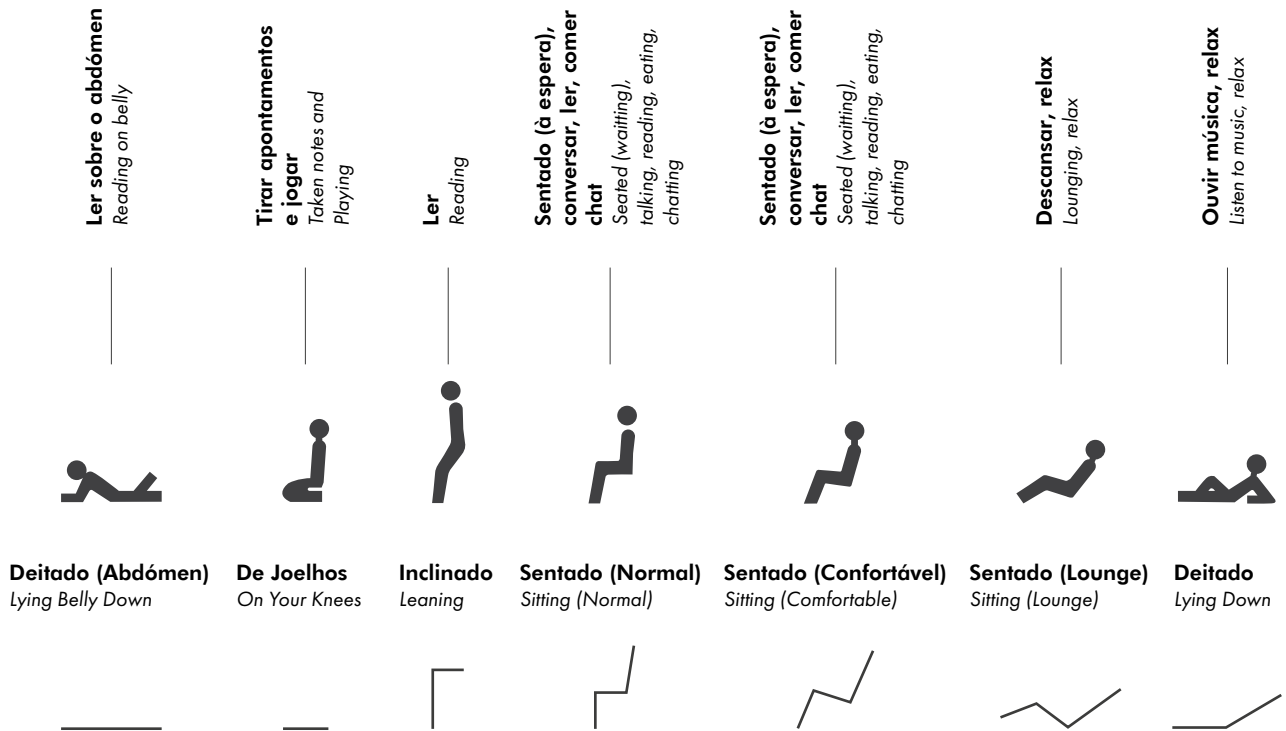

Solução 8C1

8C1 Solution

01301

1204x100x140 cm ≈ 20315 kg

Com Fundação *With Foundation* +10 cm

Encastrado Simples *Recessed Setting*

Materials Materials

Betão CS/ES
CS/ES Concrete

Acabamentos Standard Standard Finishes

Liso Pigmentado
Smooth Pigmented



Branco
White



Cinza
Grey



Pintado Cores RAL
Painted RAL Colours

Outros Acabamentos Other Finishes



Ver páginas 232-236
View pages 232-236

COIMBRA

Design João Nunes



**Banco***Bench*

Todas as arestas boleadas

All edges rounded

01105

230x99x46 cm ≈ 1710 kg

Simplesmente Apoiado *Self-Standing***Banco Madeira***Wood Bench*

Todas as arestas boleadas

All edges rounded

01185

230x99x95 cm ≈ 1585 kg

Simplesmente Apoiado *Self-Standing***Banco T (topo)***T Bench (top)*

5 Arestas boleadas

5 Rounded edges

01106

225x99x46 cm ≈ 1710 kg

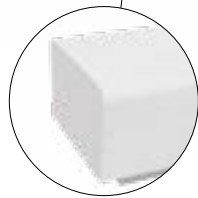
Simplesmente Apoiado *Self-Standing***Banco M (meio)***M Bench (middle)*

2 Arestas boleadas

2 Rounded edges

01107

220x99x46 cm ≈ 1710 kg

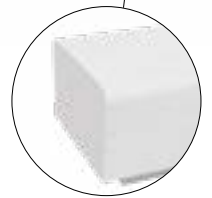
Simplesmente Apoiado *Self-Standing***AddOn Encosto Banco***Backrest Bench AddOn*

50060

70x1x42 cm ≈ 25 kg

Aparafusamento de Superfície *Surface Bolted Anchoring***Conjunto Bancos T com AddOn Encosto***Bench T Set With Backrest AddOn***Materiais Materials Acabamentos Standard Standard Finishes**Betão CS/ES
*CS/ES Concrete*Liso Pigmentado
Smooth PigmentedBranco
WhiteCinza
*Grey*Bujardado Suave
SandblastedBranco
WhiteCinza
*Grey***Outros Acabamentos Other Finishes**Madeira Tropical
*Tropical Wood*Aço Metalizado Pintado
Painted Metallized SteelPintado Cores RAL
*Painted RAL Colours***RE-CYCLE**Ver páginas 232-236
View pages 232-236

LORD

Design Studio Wave



Mesa de Picnic

Picnic Table

22005

100x100x75 cm ≈ 370 kg

Fixação de Superfície

Surface Permanent Anchoring



Mesa de Café

Coffee Table

22009

75x75x45 cm ≈ 185 kg

Fixação de Superfície

Surface Permanent Anchoring



Papeleira

Paper Bin

22007

80 L

75x38x100 cm ≈ 370 kg

Fixação de Superfície

Surface Permanent Anchoring



Banco Individual
Individual Bench
 22003
 75x75x45cm ≈ 175kg
 Fixação de Superfície
Surface Permanent Anchoring



Banco Coletivo
Collective Bench
 22004
 180x75x45 cm ≈ 340 kg
 Fixação de Superfície
Surface Permanent Anchoring



Cadeira Individual
Individual Chair
 22001
 75x75x75 cm ≈ 340 kg
 Fixação de Superfície
Surface Permanent Anchoring



Cadeira Coletiva
Collective Chair
 22002
 180x75x75 cm ≈ 570 kg
 Fixação de Superfície
Surface Permanent Anchoring



Floreira
Planter
 22006
 75x75x75 cm ≈ 400 kg
 Fixação de Superfície
Surface Permanent Anchoring

Materiais *Materials*

Betão CS/ES
CS/ES Concrete

Aço Metalizado Pintado
Painted Metallized Steel

Acabamentos Standard *Standard Finishes*

Desbastado ou Bujardado
Honed or Shot blasted



Pedra Lioz
Lioz Stone



Granito Azul
Blue Granite

Outros Acabamentos *Other Finishes*

Ver páginas 234-236 | 224
View pages 234-236 | 224

Madeira Tropical ou Plástico Reciclado
Tropical Wood or Recycled Plastic

PLANO

Design Paulo Reis



**Cúbica 1***Cubic 1*

01042

100x100x45 cm ≈ 800 kg

Com Fundação *With Foundation* +15 cmEncastrado Simples *Recessed Setting***Cúbica 1 MT***Cubic 1 MT*

01079

100x100x45 cm ≈ 830 kg

Com Fundação *With Foundation* +15 cmEncastrado Simples *Recessed Setting***Cúbica 2***Cubic 2*

01043

200x100x45 cm ≈ 1730 kg

Com Fundação *With Foundation* +15 cmEncastrado Simples *Recessed Setting*

Área útil 85,6x170,6 cm

Dois lados úteis

Braille sob consulta

*Useful Area 85,6x170,6 cm**Two useful sides**Braille on request***Cúbica 2 MT***Cubic 2 MT*

01080

200x100x97 cm ≈ 1815 kg

Com Fundação *With Foundation* +15 cmEncastrado Simples *Recessed Setting***Materiais** *Materials*Betão CS/ES
*CS/ES Concrete*Madeira Termotratada
*Thermo-treated Wood***Acabamentos Standard** *Standard Finishes*Liso Pigmentado
Smooth PigmentedBranco
WhiteCinza
GreyPintado Cores RAL
*Painted RAL Colours***Outros Acabamentos** *Other Finishes***RE-CYCLE**Ver páginas 232-236 | 224
*View pages 232-236 | 224***Add-ons**

Kit LED

OBLONG

Design Célia Peralta, CMA

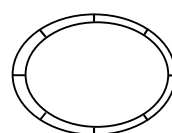

Composição 1

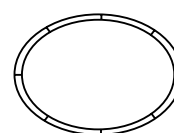

Composição 2
Sob Consulta
On Request

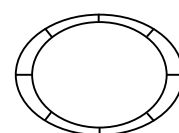

Composição 3
Sob Consulta
On Request

Banco Caldeira - Composição 1

Treesurround Bench - Composition 1

01150

968x704x46 cm ≈ 12780 kg

Fixação de Superfície Surface Permanent Anchoring

Materials Materials

Betão CS/ES
CS/ES Concrete

Acabamentos Standard Standard Finishes

Bujardado Shot Blasted  Pedra Lioz Lioz Stone  Granito Azul Blue Granite

Outros Acabamentos Other Finishes

Ver páginas 234-236
View pages 234-236

MINIMAL

Design Rui Rosmaninho



Cadeira

Chair

01125

61x98x87 cm ≈ 265 kg

Fixação de Superfície Surface Permanent Anchoring



Cadeira Dupla

Double Chair

01197

123x98x87 cm ≈ 455 kg

Fixação de Superfície Surface Permanent Anchoring

Materials Materials

Betão CS/ES
CS/ES Concrete

Acabamentos Standard Standard Finishes

Liso Pigmentado
Smooth Pigmented



Branco
White



Cinza
Grey



Pintado Cores RAL
Painted RAL Colours

Outros Acabamentos Other Finishes

Ver páginas 234-236
View pages 234-236

LUGAR COMUM

Design Daniel Caramelo



Banco Individual

Individual Bench
LC BI 400BR ST
50x50x45 cm ≈ 98 kg
Fixação de Superfície
Surface Permanent Anchoring



Cadeira Individual

Individual Chair
LC CI 400BR ST
55x65x74 cm ≈ 135 kg
Fixação de Superfície
Surface Permanent Anchoring



Cadeira Coletiva

Collective Chair
LC CC 400BR ST
200x65x74 cm ≈ 440 kg
Fixação de Superfície
Surface Permanent Anchoring



Banco Coletivo

Collective Bench

LC BC 400BR ST

200x50x45 cm ≈ 315 kg

Fixação de Superfície

Surface Permanent Anchoring



Mesa Banco

Bench Table

LC MB 400BR ST

100x100x45 cm ≈ 335 kg

Fixação de Superfície

Surface Permanent Anchoring



Mesa

Table

LC MS 400BR ST

100x100x76 cm ≈ 365 kg

Fixação de Superfície

Surface Permanent Anchoring

LUGAR COMUM

Design Daniel Caramelo



Papeleira S

Paper Bin S

LC PS 400BR

Ø 45x60 cm ≈ 105 kg

20 L

Fixação de Superfície *Surface Permanent Anchoring*



Papeleira L

Paper Bin L

LC PL 400BR

Ø 60x85 cm ≈ 220 kg

80 L

Fixação de Superfície *Surface Permanent Anchoring*



Bebedouro

Fountain

LC B 400BR

68x45x80 cm ≈ 320 kg

Com Fundação *With Foundation +30 cm*

Encastrado com Fixação *Anchored Recessed Setting*



Floreira S

Planter S

LC FS 400BR

Ø 45x60 cm ≈ 118 kg

Fixação de Superfície *Surface Permanent Anchoring*



Floreira L

Planter L

LC FL 400BR

Ø 60x85 cm ≈ 250 kg

Fixação de Superfície *Surface Permanent Anchoring*



Floreira XL

Planter XL

LC FXL 400BR

Ø 100x100 cm ≈ 710 kg

Fixação de Superfície *Surface Permanent Anchoring*



Cadeira Coletiva
Collective Chair
 LC CC 400NG AZ02

Base em Betão CS/ES Liso Pigmentado
CS/ES Smooth Pigmented Concrete Base



Branco
White
 400 BR

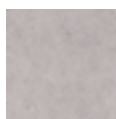

Cinza
Grey
 400 CZ



Negro
Black
 400 NG

Assento e Encosto
Seat and Backrest



Azulejo Pérola
Pearl Tile
 AZ01



**Azulejo Pérola/
 Vermelho**
Pearl Tile/ Red
 AZ02





Banco Individual

Individual Bench

LC BI AMP 7016 CM01

50x50x45 cm ≈ 45 kg

Fixação de Superfície *Surface Permanent Anchoring*



Cadeira Individual

Individual Chair

LC CI AMP 7016 CM01

55x65x74 cm ≈ 65 kg

Fixação de Superfície *Surface Permanent Anchoring*



Cadeira Coletiva

Collective Chair

LC CC AMP 7016 CM01

200x65x74 cm ≈ 210 kg

Fixação de Superfície *Surface Permanent Anchoring*



Banco Coletivo

Collective Bench

LC BC AMP 7016 CM01

200x50x45 cm ≈ 120 kg

Fixação de Superfície *Surface Permanent Anchoring*



Mesa Banco

Bench Table

LC MB AMP 7016 CM01

100x100x45 cm ≈ 125 kg

Fixação de Superfície *Surface Permanent Anchoring*



Mesa

Table

LC MS AMP 7016 CM01

100x100x76 cm ≈ 135 kg

Fixação de Superfície *Surface Permanent Anchoring*

LUGAR COMUM

Design Daniel Caramelo



Papeleira S

Paper Bin S

LC PS AMP 7016

Ø 45x60 cm ≈ 37 kg

20 L

Fixação de Superfície *Surface Permanent Anchoring*



Papeleira L

Paper Bin L

LC PL AMP 7016

Ø 60x85 cm ≈ 70 kg

80 L

Fixação de Superfície *Surface Permanent Anchoring*



Bebedouro

Fountain

LC B 400BR AMP 7016

68x45x80 cm ≈ 220 kg

Com Fundação *With Foundation +30 cm*

Encastrado com Fixação *Anchored Recessed Setting*



Floreira S

Planter S

LC FS AMP 7016

Ø 45x60 cm ≈ 45 kg

Fixação de Superfície *Surface Permanent Anchoring*



Floreira L

Planter L

LC FL AMP 7016

Ø 60x85 cm ≈ 80 kg

Fixação de Superfície *Surface Permanent Anchoring*



Floreira XL

Planter XL

LC FXL AMP 7016

Ø 100x100 cm ≈ 200 kg

Fixação de Superfície *Surface Permanent Anchoring*



Cadeira Coletiva
Collective Chair
 LC CC AMP 7016 CM01

Base em Aço Metalizado Pintado
Painted Metallized Steel Base



Branco
 White
 RAL 9010



Cinza
 Grey
 RAL 7001



Preto
 Black
 RAL 9017



Antracite Micro Texturado
 Micro Textured
 Anthracite
 RAL 7016



Azul
 Blue
 RAL 5024



Vermelho
 Red
 RAL 3022



Verde
 Green
 RAL 6021



Amarelo
 Yellow
 RAL 1012

Assento e Encosto
Seat and Backrest



Contraplacado Marítimo em Acabamento Bétula
 Maritime Plywood
 in Birch Finishing
 CM01

MIA

Design António Carvalho



Banco
Bench
11001
150x67x86 cm ≈ 1290 kg
Simplesmente Apoiado *Self-Standing*



Banco Côncavo R190 - 45°
Concave Bench R190 - 45°
11002
197x67x86 cm ≈ 1500 kg
Simplesmente Apoiado *Self-Standing*



Banco Convexo R190 - 45°
Convex Bench R190 - 45°
11003
197x67x86 cm ≈ 1490 kg
Simplesmente Apoiado *Self-Standing*

**Bebedouro***Fountain*

11005

37x55x80 cm ≈ 120 kg

Encastrado Simples *Recessed Setting***Papeleira***Paper Bin*

11004

35 L

30x40x85 cm ≈ 105 kg

Simplesmente Apoiado *Self-Standing***Dissuasor Tubarão***Shark Bollard*

11006

63x10x30 cm ≈ 60 kg

Com Fundação *With Foundation* +19 cmEncastrado Simples *Recessed Setting***Materiais Materials Acabamentos Standard Standard Finishes**Betão CS/ES
CS/ES ConcreteBujardado Suave
SandblastedBranco
WhiteCinza
GreyBujardado
Shot BlastedPedra Lioz
Lioz StoneGranito Azul
Blue Granite**Outros Acabamentos Other Finishes**Ver páginas 232-236 | 224
View pages 232-236 | 224Aço Inox ou Aço Metalizado Pintado
Stainless Steel or Painted Metallized Steel

AM

Design António Carvalho



Banco
Bench
05001
200x45x45 cm ≈ 575 kg
Simplesmente Apoiado *Self-Standing*



Banco Côncavo R235 - 45°
Concave Bench R235 - 45°
05002
180x45x45 cm ≈ 489 kg
Simplesmente Apoiado *Self-Standing*



Banco Convexo R235 - 45°
Convex Bench R235 - 45°
05003
180x45x45 cm ≈ 470 kg
Simplesmente Apoiado *Self-Standing*



Banco AM 100 Cônico R95 - 90°
AM 100 Concave Bench R95 - 90°
05014
133x45x45 cm ≈ 345 kg
Simplesmente Apoiado *Self-Standing*



Banco AM 100 Convexo R95 - 90°
AM 100 Convex Bench R95 - 90°
05005
133x45x45 cm ≈ 310 kg
Simplesmente Apoiado *Self-Standing*



Papeleira M
Paper Bin M
05006
45 L
40x30x100 cm ≈ 120 kg
Simplesmente Apoiado *Self-Standing*



Banco AMC
AMC Bench
05007
200x67x86 cm ≈ 1210 kg
Simplesmente Apoiado *Self-Standing*



Conjunto Picnic
Picnic Set
05008
200x200x80 cm ≈ 2550 kg
Simplesmente Apoiado *Self-Standing*



Banco M R95 - 270°
M Bench R95 - 270°
05004
190x45x45 cm ≈ 930 kg
Simplesmente Apoiado *Self-Standing*

Materiais Materials Acabamentos Standard Standard Finishes

Betão CS/ES
CS/ES Concrete

Bujardado Suave
Sandblasted



Branco
White



Cinza
Grey

Bujardado
Shot Blasted



Pedra Lioz
Lioz Stone



Granito Azul
Blue Granite

Aço Inox ou Aço Metalizado Pintado
Stainless Steel or Painted Metallized Steel

Outros Acabamentos Other Finishes

RE-CYCLE Ver páginas 232-236 | 224
View pages 232-236 | 224

Add-ons

Kit LED

CITIZEN

Design Eduardo Mota



Banco

Bench

09001

120x60x45 cm ≈ 250 kg

Aparafusamento de Superfície *Surface Bolted Anchoring*



Floreira P

P Planter

09002

120x60x43 cm ≈ 400 kg

Simplemente Apoiado *Self-Standing*



Floreira G

G Planter

09003

120x60x61 cm ≈ 525 kg

Simplemente Apoiado *Self-Standing*



Ecoponto 3x30L
 Citizen Ecopoint 3x30L
 09010
 90x36x86 cm ≈ 420 kg
 Simplesmente Apoiado *Self-Standing*



Ecoponto 2x45L
 Citizen Ecopoint 2x45L
 09009
 90x36x86 cm ≈ 420 kg
 Simplesmente Apoiado *Self-Standing*



Papeleira 40L
 40L Paper Bin
 09005
 42 L
 45x45x86 cm ≈ 280 kg
 Fixação de Superfície *Surface Permanent Anchoring*



Papeleira 20L
 20L Paper Bin
 09004
 20 L
 36x36x86 cm ≈ 200 kg
 Fixação de Superfície *Surface Permanent Anchoring*



Combi Papeleira + Cinzeiro
 Combi Paper Bin + Ashtray
 09006
 36x51x86 cm ≈ 210 kg
 20 L + 4 L
 Fixação de Superfície *Surface Permanent Anchoring*



Ecoponto 40L
 Recycle Bin 40L
 09008
 42 L
 45x45x86 cm ≈ 280 kg
 Fixação de Superfície *Surface Permanent Anchoring*



Ecoponto 20L
 Recycle Bin 20L
 09007
 20 L
 36x36x86 cm ≈ 200 kg
 Fixação de Superfície *Surface Permanent Anchoring*



Cores Disponíveis
 Available Colors
 Azul (Blue) RAL 5005,
 Vermelho (Red) RAL 3001,
 Verde (Green) RAL 6016,
 Preto (Black) RAL 9005,
 Amarelo (Yellow) RAL 1021
 Castanho (Brown) RAL 8011

Materiais Materials Acabamentos Standard Standard Finishes

Betão CS/ES
 CS/ES Concrete

Bujardado Suave
 Sandblasted

Branco
 White

Cinza
 Grey

Bujardado
 Shot Blasted

Pedra Lioz
 Lioz Stone

Granito Azul
 Blue Granite

Aço Inox, Aço Corten ou Aço Metalizado Pintado
 Stainless Steel, Corten Steel or Painted Metallized Steel

Pintado Cores RAL
 Painted RAL Colours

Outros Acabamentos Other Finishes

RE-CYCLE Ver páginas 232-236 | 224
 View pages 232-236 | 224

MATEUS

Design António Carvalho

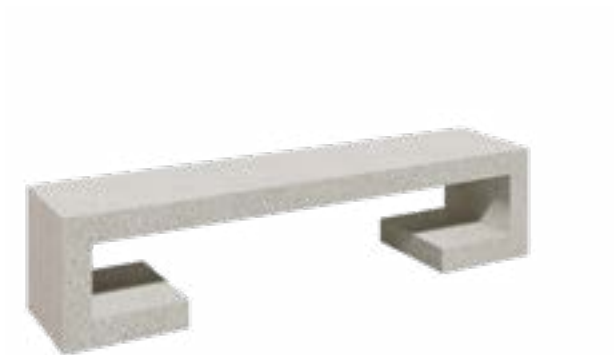

**Banco***Bench*

06001

200x45x45 cm ≈ 380 kg

Simplesmente Apoiado *Self-Standing***Papeleira***Paper Bin*

06003

45 L

30x40x85 cm ≈ 110 kg

Simplesmente Apoiado *Self-Standing***Mesa***Table*

06004

200x100x80 cm ≈ 1025 kg

Simplesmente Apoiado *Self-Standing***Conjunto Picnic***Picnic Set*

06002

200x210x80 cm ≈ 1790 kg

Simplesmente Apoiado *Self-Standing***Materiais** *Materials*Betão CS/ES
*CS/ES Concrete***Acabamentos Standard** *Standard Finishes*Bujardado Suave
SandblastedBranco
WhiteCinza
*Grey*Bujardado
Shot BlastedPedra Lioz
Lioz StoneGranito Azul
*Blue Granite***Outros Acabamentos** *Other Finishes*Ver páginas 234-236 | 224
*View pages 234-236 | 224*Aço Inox ou Aço Metalizado Pintado
Stainless Steel or Painted Metallized Steel

ÁGUEDA

Design Amop



**Banco Com Costas***Bench With Backrest*

01011

300x65x120 cm ≈ 1590 kg

Simplesmente Apoiado *Self-Standing***Banco Com Painei***Bench With Panel*

01047

300x65x120 cm ≈ 1590 kg

Simplesmente Apoiado *Self-Standing*

Área útil 186x106 cm
 Standard: Vinil Impresso
 Braille sob consulta
 Useful Area 186x106 cm
 Standard: Printed Vinyl
 Braille on request

**Banco Sem Costas***Bench Without Backrest*

01012

250x50x45 cm ≈ 600 kg

Simplesmente Apoiado *Self-Standing***Banco Com Costas Duplo***Double Bench With Backrest*

01013

400x115x120 cm ≈ 2270 kg

Simplesmente Apoiado *Self-Standing*

HYBRID

Design Brimet da Silva



**Dissuasor Fraktal Metaform***Fraktal Metaform Bollard*

01068

29x19x91 cm ≈ 10 kg

Aparafusamento de Superfície *Surface Bolted Anchoring***Cinzeiro Fraktal Metaform***Fraktal Metaform Ashtray*

01069

29x19x91 cm ≈ 10 kg

Aparafusamento de Superfície *Surface Bolted Anchoring***Papeleira + Cinzeiro Fraktal Metaform***Fraktal Metaform Paper Bin + Ashtray*

01074

45 L

43x50x93 cm ≈ 15 kg

Aparafusamento de Superfície *Surface Bolted Anchoring***Dissuasor Fraktal Moove***Fraktal Moove Bollard*

01071

29x19x91 ≈ 10 kg

Aparafusamento de Superfície *Surface Bolted Anchoring***Cinzeiro Fraktal Moove***Fraktal Moove Ashtray*

01072

29x19x91 cm ≈ 10 kg

Aparafusamento de Superfície *Surface Bolted Anchoring***Papeleira + Cinzeiro Fraktal Moove***Fraktal Moove Paper Bin + Ashtray*

01075

45 L

43x50x93 cm ≈ 15 kg

Aparafusamento de Superfície *Surface Bolted Anchoring***Materiais** *Materials*Aço Corten ou Aço Metalizado Pintado
*Corten Steel or Painted Metallized Steel***Acabamentos Standard** *Standard Finishes*Antracite Micro Texturado
Micro Anthracite TexturePintado Cores RAL
*Painted RAL Colours***Outros Acabamentos** *Other Finishes*Ver páginas 224
*View pages 224***Add-ons**

Kit LED

GEOMETAL

Amop





Papeleira Tube
Tube Paper Bin
 01171
 30 L
 Ø 32x103 cm ≈ 32 kg
 Fixação de Superfície
Surface Permanent Anchoring



Papeleira Magestic
Magestic Paper Bin
 01146
 60 L
 Ø 43x85 cm ≈ 56 kg
 Fixação de Superfície
Surface Permanent Anchoring



Papeleira Slim
Slim Paper Bin
 01145
 30 L
 Ø 32x84 cm ≈ 52 kg
 Fixação de Superfície
Surface Permanent Anchoring



Floreira Tube Model I 50
Planter Tube Model I 50
 01174
 Ø 36x50 cm ≈ 16 kg
 Fixação de Superfície
Surface Permanent Anchoring
 Simplesmente Apoiado *Self-Standing*



Floreira Tube Model I 100
Planter Tube Model I 100
 01173
 Ø 36x100 cm ≈ 32 kg
 Fixação de Superfície
Surface Permanent Anchoring
 Simplesmente Apoiado *Self-Standing*



Bebedouro Tube
Tube Fountain
 01172
 Ø 33x60x90 cm ≈ 80 kg
 Encastrado Simples *Recessed Setting*
 Betão CS/ES *CS/ES Concrete*



Floreira Tube Model II 30
Planter Tube Model II 30
 01176
 Ø 100x30 cm ≈ 32 kg
 Fixação de Superfície
Surface Permanent Anchoring
 Simplesmente Apoiado *Self-Standing*



Floreira Tube Model II 50
Planter Tube Model II 50
 01175
 Ø 100x50 cm ≈ 48 kg
 Fixação de Superfície
Surface Permanent Anchoring
 Simplesmente Apoiado *Self-Standing*



Floreira Pyramidal 100
Pyramidal Planter 100
 01170
 100x100x66 cm ≈ 176 kg
 Fixação de Superfície
Surface Permanent Anchoring
 Simplesmente Apoiado *Self-Standing*

Materials *Materials*

Aço Metalizado Pintado
Painted Metallized Steel

Acabamentos Standard *Standard Finishes*



Antracite Micro Texturado
Micro Textured Anthracite



Pintado Cores RAL
Painted RAL Colours

Outros Acabamentos *Other Finishes*

Ver páginas 224
View pages 224

GEOMETAL

Amop



Floreira Square 45 5050

Square Planter 45 5050
01271

50x50x45 cm ≈ 33 kg

Fixação de Superfície

Surface Permanent Anchoring

Simplemente Apoiado Self-Standing



Floreira Square 45 35100

Square Planter 45 35100
01270

100x35x45 cm ≈ 44 kg

Fixação de Superfície

Surface Permanent Anchoring

Simplemente Apoiado Self-Standing



Floreira Square 45 50100

Square Planter 45 50100
01272

100x50x45 cm ≈ 52 kg

Fixação de Superfície

Surface Permanent Anchoring

Simplemente Apoiado Self-Standing



Floreira Square 45 50150

Square Planter 45 50150
01273

150x50x45 cm ≈ 68 kg

Fixação de Superfície

Surface Permanent Anchoring

Simplemente Apoiado Self-Standing



Floreira Square 45 100100

Square Planter 45 100100
01274

100x100x45 cm ≈ 75 kg

Fixação de Superfície

Surface Permanent Anchoring

Simplemente Apoiado Self-Standing



Caldeira Model I Q120

Treesurround Model I Q120
01280

120x120x6 cm ≈ 140 kg

Encastrado com fixação

Anchored Recessed Setting

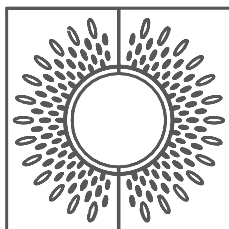

Caldeira Model II Q120

Treesurround Model II Q120
01281

120x120x6 cm ≈ 130 kg

Encastrado com fixação

Anchored Recessed Setting

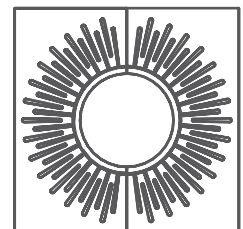



Banco de Encosto Model I 150

Back Seat Model I 150

01177

150x22x81 cm ≈ 65 kg

Aparafusamento de Superfície

Surface Bolted Anchoring



Banco de Encosto Model II 150

Back Seat Model II 150

01178

150x23x82 cm ≈ 71 kg

Aparafusamento de Superfície Surface Bolted Anchoring

Plástico Reciclado Recycled Plastic



Stop Bicicletas Combi 60 Duplo

Double 60 Combi Bicycle Rack

01148

60x84x45 cm ≈ 32 kg

Aparafusamento de Superfície

Surface Bolted Anchoring



Stop Bicicletas Combi 240 Duplo

Double 240 Combi Bicycle Rack

01179

240x84x45 cm ≈ 112 kg

Aparafusamento de Superfície

Surface Bolted Anchoring



Stop Bicicleta Combi 60

60 Combi Bicycle Rack

01147

60x42x45 cm ≈ 16 kg

Aparafusamento de Superfície

Surface Bolted Anchoring



Stop Bicicleta Combi 240

240 Combi Bicycle Rack

01149

240x42x45 cm ≈ 56 kg

Aparafusamento de Superfície

Surface Bolted Anchoring

Materials Materials

Aço Metalizado Pintado
Painted Metallized Steel

Acabamentos Standard Standard Finishes



Antracite Micro Texturado
Micro Textured Anthracite



Pintado Cores RAL
Painted RAL Colours

Outros Acabamentos Other Finishes

Ver páginas 224
View pages 224

GEOMETAL

Amop



**Light Shader***Light Shader*

02201 Ø 1000x275 cm ≈ 87 kg

02202 Ø 1000x295 cm ≈ 89 kg

02203 Ø 1000x315 cm ≈ 94 kg

Chumbadouro de Superfície *Surface Platform Anchoring*
Design Galbilec - Eugénia Leite**Light Shader***Light Shader*

02204 Ø 1500x275 cm ≈ 128 kg

02205 Ø 1500x295 cm ≈ 130 kg

02206 Ø 1500x315 cm ≈ 136 kg

Chumbadouro de Superfície *Surface Platform Anchoring*
Design Galbilec - Eugénia Leite**Light Shader***Light Shader*

02207 Ø 2000x275 cm ≈ 186 kg

02208 Ø 2000x295 cm ≈ 190 kg

02209 Ø 2000x315 cm ≈ 196 kg

Chumbadouro de Superfície *Surface Platform Anchoring*
Design Galbilec - Eugénia Leite**Light Shader***Light Shader*

02210 Ø 2500x275 cm ≈ 260 kg

02211 Ø 2500x295 cm ≈ 266 kg

02212 Ø 2500x315 cm ≈ 274 kg

Chumbadouro de Superfície *Surface Platform Anchoring*
Design Galbilec - Eugénia Leite**Materiais** *Materials*Aço Metalizado Pintado
*Painted Metallized Steel***Acabamentos Standard** *Standard Finishes*
 Antracite Micro Texturado
Micro Textured Anthracite
 Pintado Cores RAL
Painted RAL Colours
Outros Acabamentos *Other Finishes*Ver páginas 224
View pages 224

MUNDA

Design Carlos Reis Figueiredo



Banco 370

Bench 370

01250

370x200x40 cm ≈ 6705 kg

Com Fundação *With Foundation* +20 cm

Simplemente Apoiado *Self-Standing*



Mega-Lajeta

Mega-Paving Flag

12006

140x100x6 cm ≈ 150 kg/m²

PRIVATE

Materiais *Materials*

Betão CS/ES
CS/ES Concrete

Aço Inox ou Aço Metalizado Pintado
Stainless Steel or Painted Metallized Steel

Acabamentos Standard *Standard Finishes*

Liso Pigmentado
Smooth Pigmented



Branco
White



Cinza
Grey

Bujardado
Shot Blasted



Pedra Lioz
Lioz Stone



Granito Azul
Blue Granite

Outros Acabamentos *Other Finishes*

Ver páginas 234-236 | 224
View pages 234-236 | 224

Add-ons

Kit LED

FRESTA

Design Manuel Netto / Manuel Chichorro



Papeleira

Paper Bin

01262

35x48x110 cm ≈ 104 kg

100 L

Aparafusamento de Superfície

Surface Bolted Anchoring



Banco Coletivo 150

Collective Bench 150

01260

150x45x45 cm ≈ 174 kg

Aparafusamento de Superfície

Surface Bolted Anchoring



Mesa 150

Table 150

01261

150x80x74 cm ≈ 305 kg

Aparafusamento de Superfície

Surface Bolted Anchoring

Materials Materials

Aço Metalizado Pintado
Painted Metallized Steel

Betão UHPC Liso ou Bujardado Suave
UHPC Concrete Smooth or Sandblasted

Acabamentos Standard Standard Finishes

 Antracite Micro Texturado
Micro Textured Anthracite

 Pintado Cores RAL
Painted RAL Colours

Outros Acabamentos Other Finishes

Ver páginas 224 | 230-231
View pages 224 | 230 - 231

TEJO

Design F|C Arquitetura Paisagista



Cadeira Côncava R210-60°

Concave Chair R210-60°

01502

210x60x68 cm ≈ 950 kg

Aparafusamento de Superfície *Surface Bolted Anchoring*



Cadeira Convexa R210-60°

Convex Chair R210-60°

01503

210x60x68 cm ≈ 920 kg

Aparafusamento de Superfície *Surface Bolted Anchoring*



Banco Curvo R160-90°

Curve Bench R160-90°

01510

226x60x40 cm ≈ 930 kg

Aparafusamento de Superfície *Surface Bolted Anchoring*



Cadeira Coletiva 240
Collective Chair 240
 01501
 246x60x68 cm ≈ 1215 kg
 Aparafusamento de Superfície *Surface Bolted Anchoring*



Cadeira Coletiva 240 M (meio)
Collective Chair 240 M (middle)
 01506
 240x60x68 cm ≈ 1195 kg
 Aparafusamento de Superfície *Surface Bolted Anchoring*



Cadeira Coletiva 240 TE (topo esquerdo)
Collective Chair 240 TE (left top)
 01505
 240x60x68 cm ≈ 1195 kg
 Aparafusamento de Superfície *Surface Bolted Anchoring*



Cadeira Coletiva 240 TD (topo direito)
Collective Chair 240 TD (right top)
 01504
 240x60x68 cm ≈ 1195 kg
 Aparafusamento de Superfície *Surface Bolted Anchoring*

Materiais Materials **Acabamentos Standard Standard Finishes**

Betão CS/ES
CS/ES Concrete

Liso Pigmentado
Smooth Pigmented



Branco
White



Cinza
Grey

Bujardado Suave
Sandblasted



Branco
White



Cinza
Grey

Outros Acabamentos Other Finishes

Aço Corten ou Aço Metalizado Pintado
Corten Steel or Painted Metallized Steel



Pintado Cores RAL
Painted RAL Colours

RE-CYCLE

Ver páginas 232-236
View pages 232-236

TEJO

Design F|C Arquitetura Paisagista



Banco Coletivo 300

Collective Bench 300

01507

306x60x40 cm ≈ 1390 kg

Aparafusamento de Superfície Surface Bolted Anchoring



Banco Coletivo 300 T (topo)

Collective Bench 300 T (top)

01508

300x60x40 cm ≈ 1365 kg

Aparafusamento de Superfície Surface Bolted Anchoring



Banco Coletivo 300 M (meio)

Collective Bench 300 M (middle)

01509

300x60x40 cm ≈ 1365 kg

Aparafusamento de Superfície Surface Bolted Anchoring

Outras Opções de Instalação Sob Consulta

Other Installation Options On Request

Suportes de Aço Reguláveis Levelled Steel Supports

Suportes de Betão Maciços Concrete Base Supports

Aplicado ao Nível do Solo Applied at Ground Level

Materials Materials Acabamentos Standard Standard Finishes

Betão CS/ES
CS/ES Concrete

Liso Pigmentado
Smooth Pigmented



Branco
White



Cinza
Grey

Bujardado Suave
Sandblasted



Branco
White



Cinza
Grey

Aço Corten ou Aço Metalizado Pintado
Corten Steel or Painted Metallized Steel



Pintado Cores RAL
Painted RAL Colours

Outros Acabamentos Other Finishes

RE-CYCLE

Ver páginas 232-236
View pages 232-236



CONFORT

Design Amop



Banco 1M
Bench 1M
01601
100x60x34 cm ≈ 500 kg
Simplesmente Apoiado *Self-Standing*



Banco 1M Com Assento
Bench 1M With Seat
01603
100x60x39 cm ≈ 520 kg
Simplesmente Apoiado *Self-Standing*



Banco 1M Com Encosto
Bench 1M With Backrest
01604
100x60x83 cm ≈ 530 kg
Simplesmente Apoiado *Self-Standing*

**Banco 2M**

Bench 2M
01602
200x60x34 cm ≈ 995 kg
Simplesmente Apoiado Self-Standing

**Banco 2M Com Assento**

Bench 2M With Seat
01605
200x60x39 cm ≈ 1040 kg
Simplesmente Apoiado Self-Standing

**Banco 2M Com Encosto 2M**

Bench 2M With Backrest
01606
200x60x83 cm ≈ 1060 kg
Simplesmente Apoiado Self-Standing

**Banco 2M Com Encosto E (esquerda)**

Bench 2M With Seat and Backrest E (left)
01607
200x60x83 cm ≈ 1050 kg
Simplesmente Apoiado Self-Standing

Banco 2M Com Encosto D (direita)

Bench 2M With Seat and Backrest D (right)
01608

**Conjunto**

Set

Materiais Materials Acabamentos Standard Standard Finishes

Betão CS/ES
CS/ES Concrete

Liso Pigmentado
Smooth Pigmented



Branco
White



Cinza
Grey

Bujardado
Shot Blasted



Pedra Lioz
Lioz Stone



Granito Azul
Blue Granite

Outros Acabamentos Other Finishes

RE-CYCLE Ver páginas 232-236 | 224
View pages 232-236 | 224

Madeira Tropical
Tropical Wood

TOKYO

Design Ricardo Vieira de Melo



Banco Individual
Individual Bench
 01151
 50x50x45 cm ≈ 90 kg
 Fixação de Superfície
Surface Permanent Anchoring



Papeleira A
Paper Bin A
 01160
 20 L
 40x40x57 cm ≈ 115 kg
 Fixação de Superfície
Surface Permanent Anchoring



Bebedouro
Fountain
 01161
 35x35x85 cm ≈ 95 kg
 Com Fundação *With Foundation +13 cm*
 Encastrado Rígido *Concrete Base Setting*

**Banco Coletivo 240***Collective Bench 240*

01152

240x50x45 cm ≈ 350 kg

Fixação de Superfície

Surface Permanent Anchoring**Banco Coletivo R180 - 60°***Collective Bench R1080 - 60°*

01159

179x50x45 cm ≈ 290 kg

Fixação de Superfície

Surface Permanent Anchoring**Banco Coletivo 240 ACM***Collective Bench 240 ACM*

01154

240x60x73 cm ≈ 355 kg

Fixação de Superfície

Surface Permanent Anchoring**Banco Coletivo 240 AM***Collective Bench 240 AM*

01153

240x50x45cm ≈ 335 kg

Fixação de Superfície

Surface Permanent Anchoring**Banco Coletivo 340***Collective Bench 340*

01155

340x50x45cm ≈ 505 kg

Fixação de Superfície

Surface Permanent Anchoring**Mesa 240***Table 240*

01162

240x80x73cm ≈ 585 kg

Fixação de Superfície

*Surface Permanent Anchoring***Materiais** *Materials*Betão CS/ES
*CS/ES Concrete***Acabamentos Standard** *Standard Finishes*Liso Pigmentado
Smooth PigmentedBranco
WhiteCinza
*Grey*Bujardado Suave
SandblastedBranco
WhiteCinza
*Grey***Outros Acabamentos** *Other Finishes*Ver páginas 234-236 | 224
*View pages 234-236 | 224*Madeira Termotratada ou Plástico Reciclado
*Thermo-treated Pine or Recycled Plastic***Add-ons**

Kit LED

MUL

Design Spaceworkers



Banco Coletivo

Collective Bench

01407

135x45x45 cm ≈ 615 kg

Simplemente Apoiado *Self-Standing*



Floreira Banco R1

Planter Bench R1

01401

225x45x45 cm ≈ 785 kg

Simplemente Apoiado *Self-Standing*



Papeleira

Paper Bin

01409

75 L

45x45x100 cm ≈ 40 kg

Fixação de Superfície
Surface Permanent Anchoring

**Floreira C1***Planter C1*

01402

225x45x25 cm ≈ 328 kg

Simplesmente Apoiado *Self-Standing*Sugestão *Suggestion:*Add-On Papeleira *Paper Bin* 01409**Floreira R1***Planter R1*

01404

225x45x45 cm ≈ 513 kg

Simplesmente Apoiado *Self-Standing***Floreira C2***Planter C2*

01403

135x45x25 cm ≈ 198 kg

Simplesmente Apoiado *Self-Standing*Sugestão *Suggestion:*Add-On Papeleira *Paper Bin* 01409**Floreira R2***Planter R2*

01405

135x45x25 cm ≈ 213 kg

Simplesmente Apoiado *Self-Standing***Floreira Q1***Planter Q1*

01408

90x90x35 cm ≈ 328 kg

Simplesmente Apoiado *Self-Standing***Floreira R3***Planter R3*

01406

90x45x35 cm ≈ 188 kg

Simplesmente Apoiado *Self-Standing***Materiais** *Materials*Betão CS/ES
*CS/ES Concrete*Aço Metalizado Pintado
*Painted Metallized Steel***Acabamentos Standard** *Standard Finishes*Bujardado Suave
SandblastedBranco
WhiteCinza
*Grey*Desbastado
HonedPedra Lioz
Lioz StoneGranito Azul
*Blue Granite***Outros Acabamentos** *Other Finishes*Ver páginas 234-236 | 224
View pages 234-236 | 224

VOUGA RIO

Design Amop





Churrasqueira

Barbecue

01098

196x76x90 cm ≈ 1540 kg

Simplemente Apoiado *Self-Standing*

Grelha em Aço *Steel Grid*

Tijolo Refratário *Refractory Brick*



Lava Louça

Dishwasher

01184

196x76x90 cm ≈ 1540 kg

Simplemente Apoiado *Self-Standing*

Pias em Aço Inox *Stainless Steel Sink*

Aço Inox

Stainless Steel



Conjunto Picnic 4P

Picnic Set 4P

01198

200x200x82 cm ≈ 1055 kg

Com Fundação *With Foundation* +20 cm

Encastrado com Fixação *Anchored Recessed Setting*



Conjunto Picnic

Picnic Set

01022

250x165x82 cm ≈ 2830 kg

Com Fundação *With Foundation* +20 cm

Encastrado com Fixação *Anchored Recessed Setting*



GÓIS

Design Carlos Manuel Santos



Banco Reto

Straight Bench
07002

180x96x100 cm ≈ 840 kg

Com Fundação *With Foundation* +12 cm

Encastrado Simples *Recessed Setting*

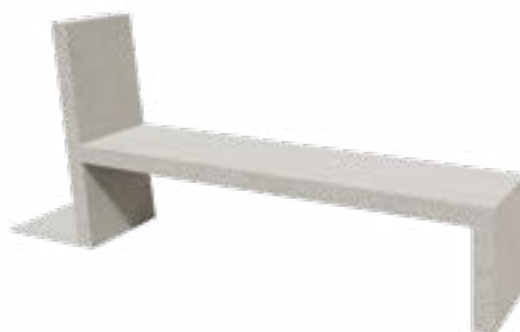

Banco com Apoio Lateral

Bench With Lateral Support
07005

231x50x100 cm ≈ 415 kg

Com Fundação *With Foundation* +12 cm

Encastrado Simples *Recessed Setting*

**Banco Individual***Individual Bench*

07001

50x96x100 cm ≈ 240 kg

Com Fundação *With Foundation* +12 cmEncastrado Simples *Recessed Setting***Bebedouro***Fountain*

07003

50x60x100 cm ≈ 180 kg

Com Fundação *With Foundation* +12 cmEncastrado Simples *Recessed Setting***Papeleira***Paper Bin*

07004

45 L

50x60x100 cm ≈ 240 kg

Com Fundação *With Foundation* +12 cmEncastrado Simples *Recessed Setting***Totem***Totem*

07007

50x60x100 cm ≈ 190 kg

Com Fundação *With Foundation* +12 cmEncastrado Simples *Recessed Setting***Conjunto Picnic***Picnic Set*

07006

282x282x100 cm ≈ 1190 kg

Com Fundação *With Foundation* +12 cmEncastrado Simples *Recessed Setting***Materiais** *Materials*Betão CS/ES
*CS/ES Concrete*Aço Inox
*Stainless Steel***Acabamentos Standard** *Standard Finishes*Bujardado Suave
SandblastedBranco
WhiteCinza
*Grey*Bujardado
Shot BlastedPedra Lioz
Lioz StoneGranito Azul
*Blue Granite***Outros Acabamentos** *Other Finishes*Ver páginas 234-236 | 224
View pages 234-236 | 224

FRAME

Design Daniel Caramelo

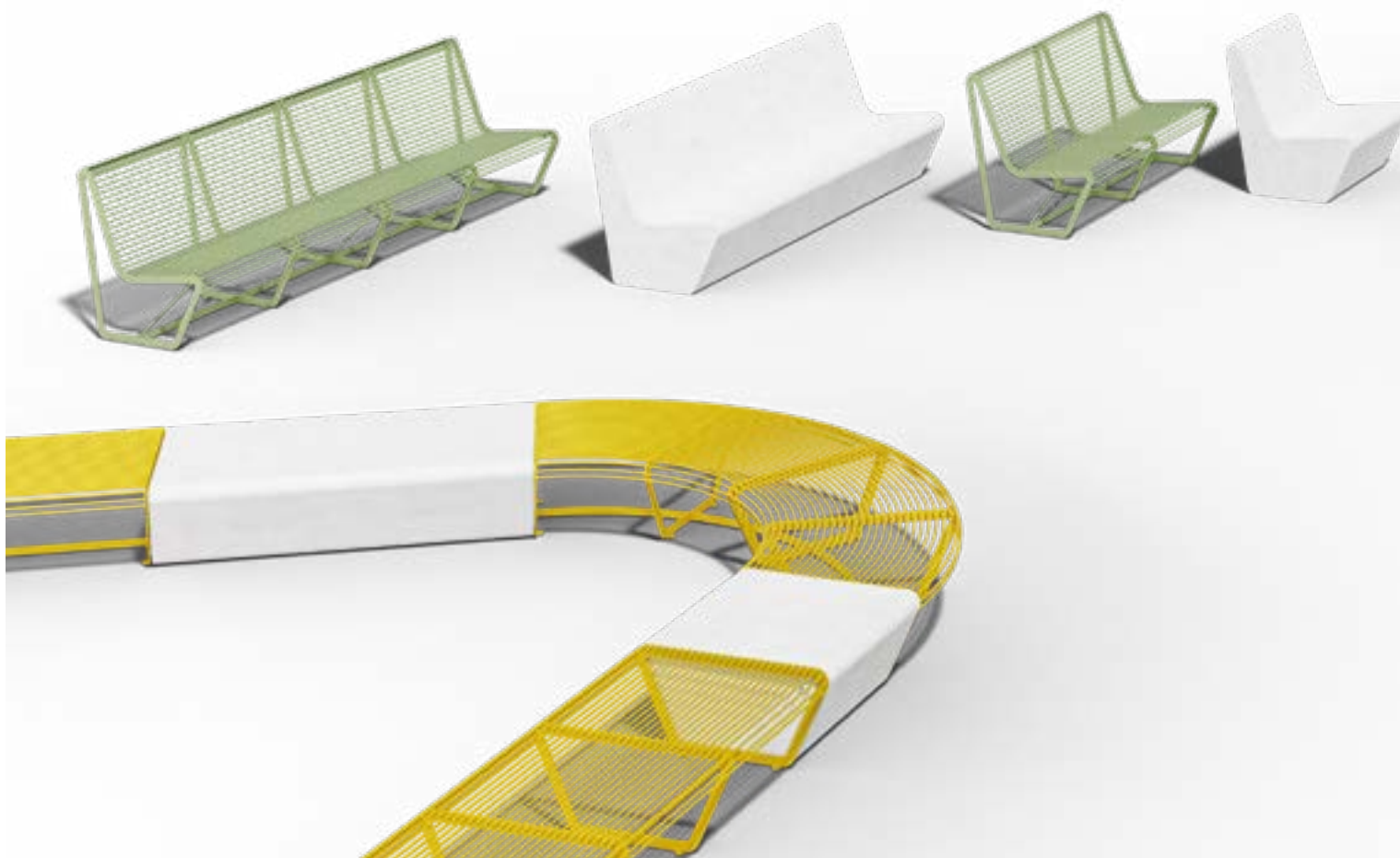

Banco Individual 80

Individual 80 Bench

01701

80x82,5x39,5 cm ≈ 35 kg

Aparafusamento de Superfície

Surface Bolted Anchoring/

Simplemente Apoiado Self-Standing



Banco Curvo R175 - 60°

Curve Bench R175 - 60°

01710

176x82,5x39,5 cm ≈ 55 kg

Aparafusamento de Superfície

Surface Bolted Anchoring/

Simplemente Apoiado Self-Standing



Cadeira Individual 80

Individual Chair 80

01704

80x81x86 cm ≈ 40 kg

Aparafusamento de Superfície

Surface Bolted Anchoring/

Simplemente Apoiado Self-Standing

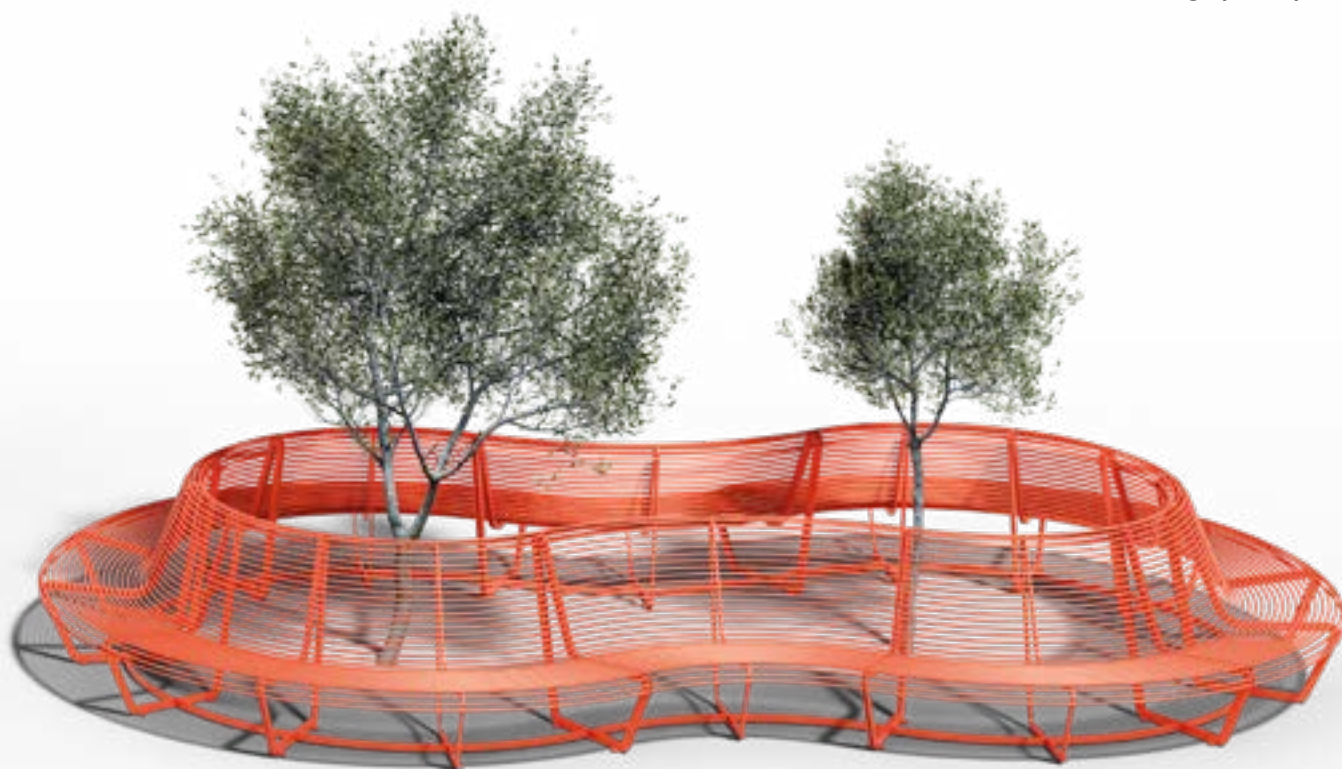

Cadeira Convexa R175 - 60°

Convex Chair R175 - 60°

01709

175x81x86 cm ≈ 75 kg

Aparafusamento de Superfície

Surface Bolted Anchoring/

Simplemente Apoiado Self-Standing



Cadeira Côncava R175 - 60°

Concave Chair R175 - 60°

01708

175x81x86 cm ≈ 75 kg

Aparafusamento de Superfície

Surface Bolted Anchoring/

Simplemente Apoiado Self-Standing



Banco Coletivo 160

Collective Bench 160

01702

160x82,5x39,5 cm ≈ 55 kg

Aparafusamento de Superfície Surface Bolted Anchoring/

Simplemente Apoiado Self-Standing

Materiais Materials

Aço Metalizado Pintado
Painted Metallized Steel

Acabamentos Standard Standard Finishes



Antracite Micro Texturado
Micro Textured Anyhracite



Pintado Cores RAL
Painted RAL Colours

Outros Acabamentos Other Finishes

Ver páginas 224
View pages 224

FRAME

Design Daniel Caramelo



Banco Coletivo 240

Collective Bench 240

01703

240x82,5x39,5 cm ≈ 90 kg

Aparafusamento de Superfície / Surface Bolted Anchoring/
Simplesmente Apoiado / Self-Standing



Banco Coletivo 300

Collective Bench 300

01715

300x82,5x39,5 cm ≈ 105 kg

Aparafusamento de Superfície / Surface Bolted Anchoring/
Simplesmente Apoiado / Self-Standing



Cadeira Coletiva 160

Collective Chair 160

01705

160x81x86 cm ≈ 80 kg

Aparafusamento de Superfície / Surface Bolted Anchoring/
Simplesmente Apoiado / Self-Standing



Cadeira Coletiva 240

Collective Chair 240

01706

240x81x86 cm ≈ 120 kg

Aparafusamento de Superfície / Surface Bolted Anchoring/
Simplesmente Apoiado / Self-Standing



Cadeira Coletiva 300

Collective Chair 300

01714

300x81x86 cm ≈ 155 kg

Aparafusamento de Superfície / Surface Bolted Anchoring/
Simplesmente Apoiado / Self-Standing



Chaise Longue 80

Chaise Longue 80

01707

80x179x86 cm ≈ 75 kg

Aparafusamento de Superfície / Surface Bolted Anchoring/
Simplesmente Apoiado / Self-Standing



Chaise Longue 160

Chaise Longue 160

01717

160x179x86 cm ≈ 145 kg

Aparafusamento de Superfície *Surface Bolted Anchoring/*
 Simplesmente Apoiado *Self-Standing*



Ecoponto 3R

Recycle Bin 3R

01724

45x45x81 cm ≈ 76 kg

Fixação de Superfície *Surface permanent anchoring*



Ecoponto 3RC

Recycle Bin 3RC

01725

45x45x81 cm ≈ 76 kg

Fixação de Superfície *Surface permanent anchoring*



Ecoponto 4R

Recycle Bin 4R

01726

45x45x81 cm ≈ 76 kg

Fixação de Superfície *Surface permanent anchoring*



Pintado à cor da separação dos resíduos
Painted in waste sorting colors

Cinzeiro
Ashtray

Betão CS/ES
CS/ES Concrete

Materials Materials

Aço Metalizado Pintado
Painted Metallized Steel

Acabamentos Standard Standard Finishes



Antracite Micro Texturado
Micro Textured Anthracite



Pintado Cores RAL
Painted RAL Colours

Outros Acabamentos Other Finishes

Ver páginas 224
View pages 224

FRAME

Design Daniel Caramelo

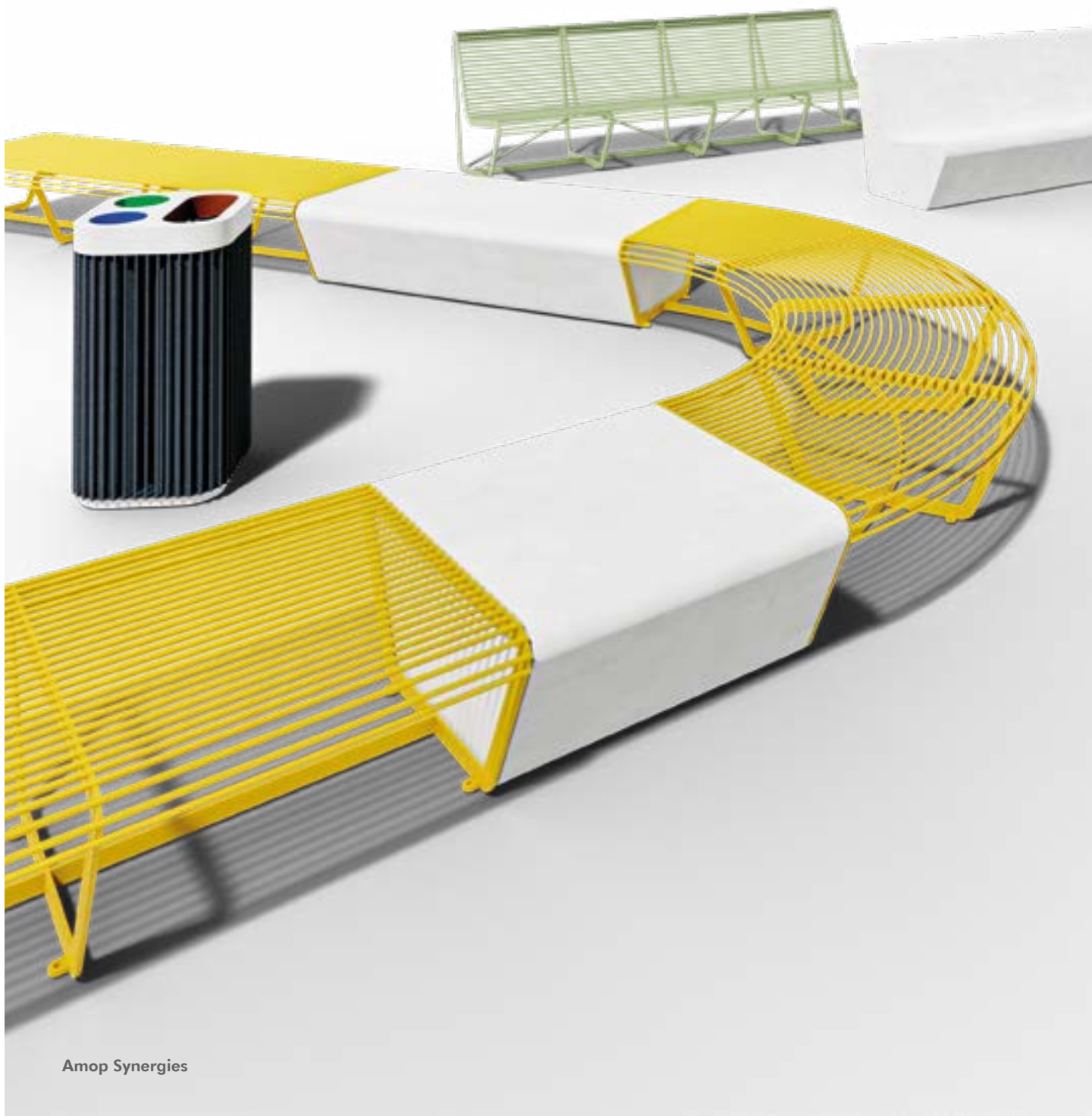

**Banco Individual BT 80***Individual Bench BT 80*

01718

80x81x39 cm ≈ 530 kg

Simplesmente Apoiado *Self-Standing***Cadeira Individual BT 80***Individual Chair BT 80*

01721

80x80x85 cm ≈ 595 kg

Simplesmente Apoiado *Self-Standing***Banco Coletivo BT 160***Collective Bench BT 160*

01719

160x81x39 cm ≈ 1055 kg

Simplesmente Apoiado *Self-Standing***Cadeira Coletiva BT 160***Collective Chair BT 160*

01722

160x80x85 cm ≈ 1190 kg

Simplesmente Apoiado *Self-Standing***Banco Coletivo BT 240***Collective Bench BT 240*

01720

240x81x39 cm ≈ 1585 kg

Simplesmente Apoiado *Self-Standing***Cadeira Coletiva BT 240***Collective Chair BT 240*

01723

240x80x85 cm ≈ 1780 kg

Simplesmente Apoiado *Self-Standing***Materiais** *Materials*Betão CS/ES
CS/ES Concrete**Acabamentos Standard** *Standard Finishes*Liso Pigmentado
Smooth PigmentedBranco
WhiteCinza
GreyBujardado Suave
SandblastedBranco
WhiteCinza
Grey**Outros Acabamentos** *Other Finishes***RE-CYCLE**Ver páginas 232-236
View pages 232-236

CRU

Design ADA - Olavo Benedito Dias e João Gago dos Santos



**Banco Individual I***Individual Bench I*

01341

74x63x40 cm ≈ 315 kg

Simplesmente Apoiado *Self-Standing***Floreira I 40***Planter I 40*

01342

74x63x40 cm ≈ 225 kg

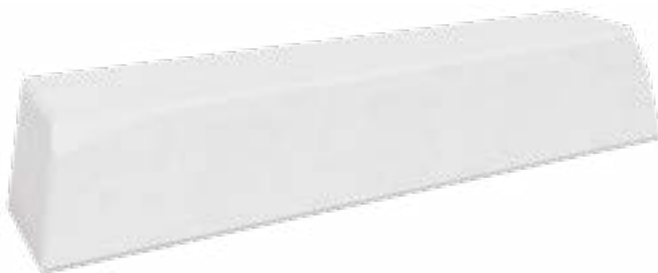
Simplesmente Apoiado *Self-Standing***Banco Coletivo I***Collective Bench I*

01340

229x59x40 cm ≈ 1075 kg

Simplesmente Apoiado *Self-Standing***Floreira II 100***Planter II 100*

01343

99x69x100 cm ≈ 675 kg

Simplesmente Apoiado *Self-Standing***Materiais Materials** **Acabamentos Standard Standard Finishes**Betão CS/ES
CS/ES ConcreteLiso Pigmentado
Smooth PigmentedBranco
WhiteCinza
GreyBujardado Suave
SandblastedBranco
WhiteCinza
Grey**Outros Acabamentos Other Finishes**Pintado Cores RAL
Painted RAL Colours**RE-CYCLE**Ver páginas 232-236
View pages 232-236

WISE

Design Amop



Banco com Costa Côncavo R260 - 45°
 Concave Bench with Back R260 - 45°
 01350
 199x67x76 cm ≈ 1100 kg
 Fixação de Superfície Surface Permanent Anchoring



Banco com Costa Convexo R260 - 45°
 Convex Bench with Back R260 - 45°
 01351
 199x67x76 cm ≈ 1100 kg
 Fixação de Superfície Surface Permanent Anchoring



Banco Curvo R260 - 45°
 Curve Bench R260 - 45°
 01352
 199x67x45 cm ≈ 850 kg
 Fixação de Superfície Surface Permanent Anchoring

Materiais Materials

Beão CS/ES
 CS/ES Concrete

Acabamentos Standard Standard Finishes

Bujardado
 Shot Blasted



Pedra Lioz
 Lioz Stone



Granito Azul
 Blue Granite

Bujardado Suave
 Sandblasted



Branco
 White



Cinza
 Grey

Outros Acabamentos Other Finishes

Ver páginas 234-236
 View pages 234-236

Add-ons

Kit LED

LINK

Design Topiaris



Banco Coletivo 100
 Collective Bench 100
 01240
 100x60x45 cm ≈ 680 kg
 Com Fundação *With Foundation* +8 cm
 Encastrado com Fixação *Anchored Recessed Setting*



Banco Curvo R100 - 90°
 Curve Bench R100 - 90°
 01241
 141x60x45 cm ≈ 775 kg
 Com Fundação *With Foundation* +8 cm
 Encastrado com Fixação *Anchored Recessed Setting*

Materiais Materials **Acabamentos Standard Standard Finishes**

Betão CS/ES
 CS/ES Concrete

Bujardado
 Shot Blasted



Pedra Lioz
 Lioz Stone



Granito Azul
 Blue Granite

Bujardado Suave
 Sandblasted



Branco
 White



Cinza
 Grey

Outros Acabamentos Other Finishes

RE-CYCLE

Ver páginas 232-236
 View pages 232-236

Add-ons

Kit Relax System

SPINNER

Design Aleksandra Matuszczak



Banco Spinner

Spinner Bench

01126

215x208x42 cm ≈ 668 kg

Fixação de Superfície *Surface Permanent Anchoring*

Materials Materials

Betão CS/ES
CS/ES Concrete

Acabamentos Standard Standard Finishes

Liso Pigmentado
Smooth Pigmented



Branco
White



Cinza
Grey

Bujardado
Shot Blasted



Pedra Lioz
Lioz Stone



Granito Azul
Blue Granite

Outros Acabamentos Other Finishes

Ver páginas 234-236 | 224
View pages 234-236 | 224

Aço Inox ou Aço Metalizado Pintado
Stainless Steel or Painted Metallized Steel

CAMDEN

Design Factory Furniture



Banco

Bench

01046

270x54x65 cm ≈ 2025 kg

Simplemente Apoiado *Self-Standing*

Banco de Segurança

Security Bench

Materiais *Materials*

Beirão CS/ES
CS/ES Concrete

Acabamentos Standard *Standard Finishes*

Bujardado ou Desbastado
Shot Blasted or Honed



Pedra Lioz
Lioz Stone



Granito Azul
Blue Granite

Outros Acabamentos *Other Finishes*

RE-CYCLE

Ver páginas 232-236
View pages 232-236

AVEIRO

Design Paulo Marinheiro

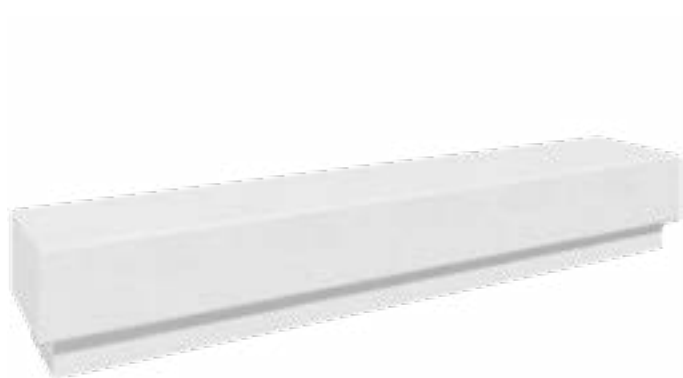

**Banco Coletivo 330**

Collective Bench 330

01360

330x60x45 cm ≈ 2640 kg

Encastrado Simples *Recessed Setting***Banco Curvo R150 - 90°**

Curve Bench R150 - 90°

01361

212x60x45 cm ≈ 1490 kg

Encastrado Simples *Recessed Setting***Banco Curvo R150 - 45°**

Curve Bench R150 - 45°

01362

115x60x45 cm ≈ 720 kg

Encastrado Simples *Recessed Setting***Banco Curvo R500 - 19°**

Curve Bench R500 - 19°

01363

163x60x45 cm ≈ 1200 kg

Encastrado Simples *Recessed Setting***Materiais Materials** **Acabamentos Standard Standard Finishes**Betão CS/ES
CS/ES ConcreteLiso Pigmentado
Smooth PigmentedBranco
WhiteCinza
GreyBujardado
Shot BlastedPedra Lioz
Lioz StoneGranito Azul
Blue Granite**Outros Acabamentos Other Finishes****RE-CYCLE**Ver páginas 232-236
View pages 232-236**Add-ons**

Kit Relax System | Kit LED

COMPORTA

Design Amop



Banco MI com Assento

MI Bench with Seat

01550

60x60x45 cm ≈ 360 kg

Simplemente Apoiado *Self-Standing*



Banco MC com Assento

MC Bench with Seat

01552

240x60x45 cm ≈ 1020 kg

Simplemente Apoiado *Self-Standing*



Banco MC com Encosto 2L
 MC Bench with Backrest 2L
 01554
 240x60x82 cm ≈ 1047 kg
 Simplesmente Apoiado Self-Standing



Banco MC com Encosto 1L
 MC Bench with Backrest 1L
 01553
 240x60x82 cm ≈ 1037 kg
 Simplesmente Apoiado Self-Standing



Banco MC com Encosto 3L
 MC Bench with Backrest 3L
 01555
 240x60x82 cm ≈ 1056 kg
 Simplesmente Apoiado Self-Standing



Banco MC com Encosto 2L+2L
 MC Bench with Backrest 2L+2L
 01557
 240x60x82 cm ≈ 1074 kg
 Simplesmente Apoiado Self-Standing



Banco MC com Encosto 1L+1L
 MC Bench with Backrest 1L+1L
 01556
 240x60x82 cm ≈ 1054 kg
 Simplesmente Apoiado Self-Standing



Banco MC com Encosto 1L+2L
 MC Bench with Backrest 1L+2L
 01558
 240x60x82 cm ≈ 1064 kg
 Simplesmente Apoiado Self-Standing

Materiais Materials Acabamentos Standard Standard Finishes

Betão CS/ES
 CS/ES Concrete

Liso Pigmentado
 Smooth Pigmented

Branco
 White

Cinza
 Grey

Bujardado
 Shot Blasted

Pedra Lioz
 Lioz Stone

Granito Azul
 Blue Granite

RE-CYCLE

Ver páginas 232-236 | 224
 View pages 232-236 | 224

Aço Inox, Aço Corten ou Aço Metalizado Pintado
 Stainless Steel, Corten Steel or Painted Metallized Steel

Madeira Tropical
 Tropical Wood

IK

Design Óscar Knoblich



Floreira IK

Planter IK
01021
120x120x120 cm ≈ 1850 kg
Simplemente Apoiado *Self-Standing*



Papeleira IK

Paper Bin IK
01015
50x50x90 cm ≈ 130 kg
45 L
Fixação de Superfície
Surface Permanent Anchoring



Papeleira IKD

Paper Bin IKD
01014
50x86x90 cm ≈ 130 kg
2x45 L
Fixação de Superfície
Surface Permanent Anchoring

Materiais *Materials*

Betão CS/ES
CS/ES Concrete

Aço Inox ou Aço Metalizado Pintado
Stainless Steel or Painted Metallized Steel

Acabamentos Standard *Standard Finishes*

Bujardado
Shot Blasted



Pedra Lioz
Lioz Stone



Granito Azul
Blue Granite

Outros Acabamentos *Other Finishes*

Ver páginas 234-236 | 224
View pages 234-236 | 224

ALGECIRAS

Design Jose Mariñas



Banco C
Bench C
01049
200x60x45 cm ≈ 925 kg
Fixação de Superfície *Surface Permanent Anchoring*



Banco W
Bench W
01048
200x60x50 cm ≈ 945 kg
Fixação de Superfície *Surface Permanent Anchoring*

Materials *Materials* Acabamentos *Standard* *Standard Finishes*

Betão CS/ES
CS/ES Concrete

Bujardado
Shot Blasted



Pedra Lioz
Lioz Stone



Granito Azul
Blue Granite

Bujardado Suave
Sandblasted



Branco
White



Cinza
Grey

Aço Corten ou Aço Metalizado Pintado
Corten Steel or Painted Metallized Steel

Madeira Tropical ou Plástico Reciclado
Tropical Wood or Recycled Plastic

Outros Acabamentos *Other Finishes*

RE-CYCLE

Ver páginas 232-236 | 224
View pages 232-236 | 224

Add-ons

Kit Relax System | Kit LED

R7M

Design Paulo Cardoso & Susana Figueiredo, CML



Banco R7M C R760-16º

R7M C Bench

01108

217x60x45 cm ≈ 880 kg

Simplemente Apoiado *Self-Standing*



Banco R7M L

R7M L Bench

01119

200x60x45 cm ≈ 840 kg

Simplemente Apoiado *Self-Standing*

Materiais *Materials* Acabamentos Standard *Standard Finishes*

Betão CS/ES
CS/ES Concrete

Liso Pigmentado
Smooth Pigmented



Branco
White



Cinza
Grey

Bujardado
Shot Blasted



Pedra Lioz
Lioz Stone



Granito Azul
Blue Granite

Outros Acabamentos *Other Finishes*

RE-CYCLE

Ver páginas 232-236
View pages 232-236

Add-ons

Kit Relax System

LC

Design Atelier Lopes da Costa



Banco LC Uno
 Uno Bench LC
 01130
 200x60x45 cm ≈ 1315 kg
 Simplesmente Apoiado *Self-Standing*



Banco LC Duo
 Duo Bench LC
 01131
 240x80x45 cm ≈ 2120 kg
 Simplesmente Apoiado *Self-Standing*

Materials *Materials*

Betão CS/ES
 CS/ES Concrete

Acabamentos Standard *Standard Finishes*

Bujardado
 Shot Blasted



Pedra Lioz
 Lioz Stone



Bujardado Suave
 Sandblasted



Branco
 White



Cinza
 Grey

Outros Acabamentos *Other Finishes*

RE-CYCLE

Ver páginas 232-236
 View pages 232-236

Add-ons

Kit Relax System

ADD-ONS Relax System

Design Amop

Acessórios

Accessories

Metal
Metal



Encosto Simples
Simple Backrest



Encosto Duplo
Double Backrest

Encosto 50 ST

Backrest 50 ST

01758

50x9x40 cm ≈ 8 kg

Aparafusamento de Superfície *Surface Bolted Anchoring*



Encosto Simples
Simple Backrest



Encosto Duplo
Double Backrest

Encosto 140 ST

Backrest 140 ST

01759

140x9x40 cm ≈ 20 kg

Aparafusamento de Superfície *Surface Bolted Anchoring*



Recomendação *Recommendation*

Recomenda-se a aplicação em bancos com pelo menos 50 cm de largura.

It is recommended to apply on benches at least 50 cm wide.



Iluminação *Lighting*

Kit LED - sob consulta

Kit LED - under request

Materials *Materials*

Aço Metalizado Pintado
Painted Metallized Steel



Antracite Micro Texturado
Micro Textured Anyhracite



Pintado Cores RAL
Painted RAL Colours

Outros Acabamentos *Other Finishes*

Ver páginas 224
View pages 224

Madeira
Wood



Encosto 50 MT

Backrest 50 MT

01750

50x10x44 cm ≈ 7 kg

Aparafusamento de Superfície Surface Bolted Anchoring



Assento + Encosto 50 MT

Seat + Backrest 50 MT

01754

50x53x44 cm ≈ 13 kg

Aparafusamento de Superfície Surface Bolted Anchoring



Encosto 140 MT

Backrest 140 MT

01752

140x10x44 cm ≈ 14 kg

Aparafusamento de Superfície Surface Bolted Anchoring



Assento + Encosto 140 MT

Seat + Backrest 140 MT

01756

140x53x44 cm ≈ 27 kg

Aparafusamento de Superfície Surface Bolted Anchoring



Assento 50 MT

Seat 50 MT

01764

50x41x2,4 cm ≈ 7 kg

Aparafusamento de Superfície Surface Bolted Anchoring



Assento 140 MT

Seat 140 MT

01765

140x41x2,4 cm ≈ 13 kg

Aparafusamento de Superfície Surface Bolted Anchoring

Materiais Materials

Aço Metalizado Pintado
Painted Metallized Steel

Madeira Termotratada
Thermo-treated Wood

Outros Acabamentos Other Finishes

Ver páginas 224
View pages 224

ADD-ONS Relax System

Design Amop

Accessories

Accessories



Encosto 50 PL

Backrest 50 PL

01751

50x10x44 cm ≈ 7 kg

Aparafusamento de Superfície *Surface Bolted Anchoring*



Plástico Reciclado

Recycled Plastic

Assento + Encosto 50 PL

Seat + Backrest 50 PL

01755

50x53x44 cm ≈ 13 kg

Aparafusamento de Superfície *Surface Bolted Anchoring*



Encosto 140 PL

Backrest 140 PL

01753

140x10x44 cm ≈ 14 kg

Aparafusamento de Superfície *Surface Bolted Anchoring*



Assento + Encosto 140 PL

Seat + Backrest 140 PL

01757

140x53x44 cm ≈ 27 kg

Aparafusamento de Superfície *Surface Bolted Anchoring*



Assento 50 PL

Seat 50 PL

01762

50x41x2,4 cm ≈ 7 kg

Aparafusamento de Superfície *Surface Bolted Anchoring*



Assento 140 PL

Seat 140 PL

01763

140x41x2,4 cm ≈ 13 kg

Aparafusamento de Superfície *Surface Bolted Anchoring*

Materials Materials

Aço Metalizado Pintado
Painted Metallized Steel

Plástico Reciclado
Recycled Plastic

Outros Acabamentos Other Finishes

Ver páginas 224
View pages 224



Sombreador Faro

Faro Sunshader

01420

Design Miguel Marques Pereira

PUMP TRACKS

Design SUBAramps

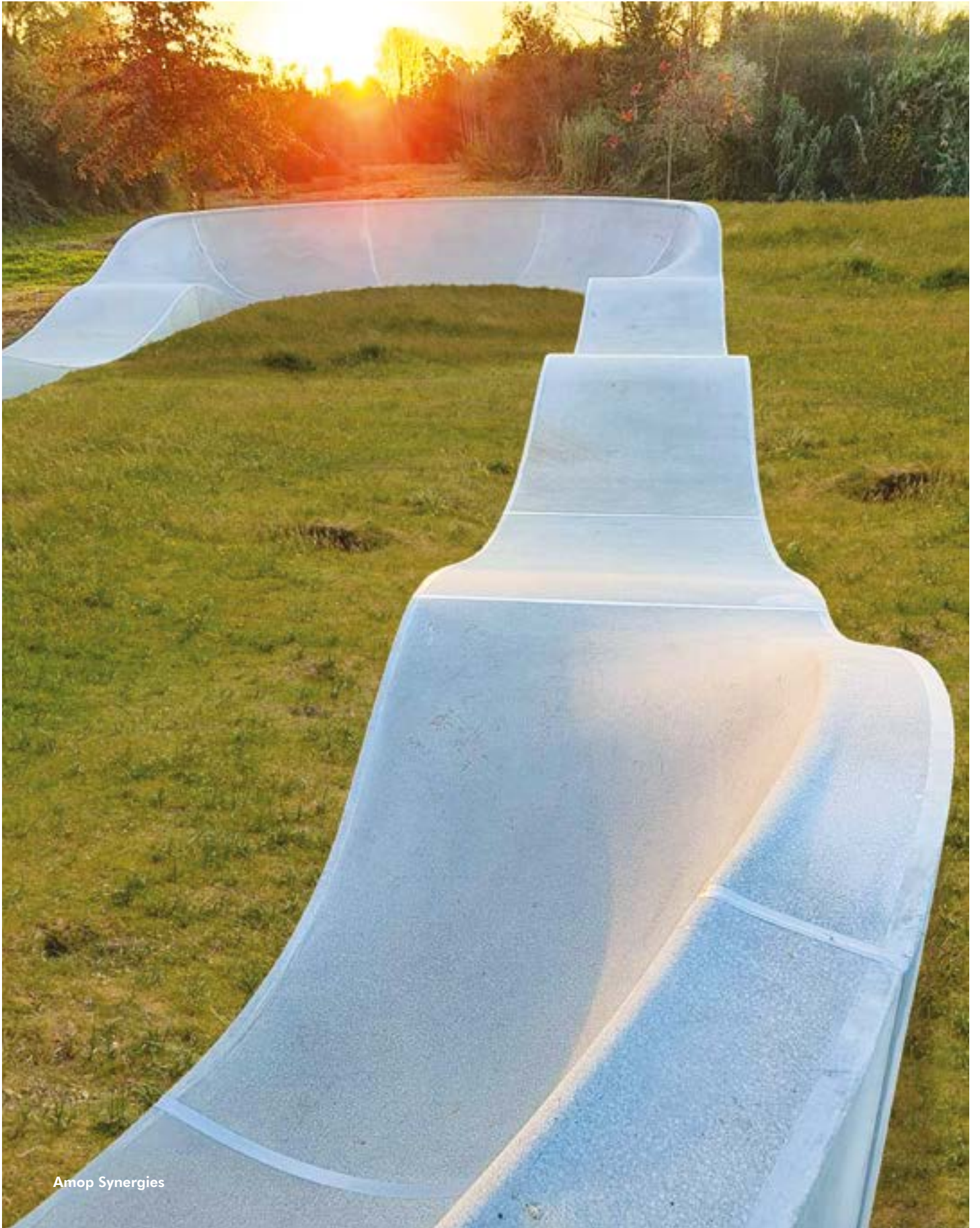

Largura da Pista Ciclável 120 cm
Cycle Lane Width 120 cm



Circuito Oval Model I

Oval Circuit Model I

01139

1511x620x100 cm ≈ 38400 kg

18 Módulos 18 Modules

Mediante Uso do Produto

Depending on Product Use



Circuito B Model I

B Circuit Model I

01140

1876x620x100 cm ≈ 53800 kg

23 Módulos 23 Modules

Mediante Uso do Produto

Depending on Product Use

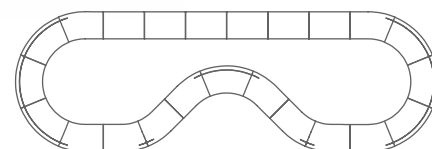

Circuito Losângulo

Diamond Circuit

01141

1898x992x100 cm ≈ 49600 kg

24 Módulos 24 Modules

Mediante Uso do Produto

Depending on Product Use

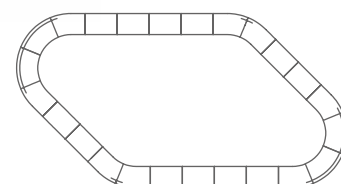

Materials Materials

Betão CS/ES
CS/ES Concrete

Acabamentos Standard Standard Finishes

Liso Pigmentado
Smooth Pigmented



Cinza
Grey



Antracite
Anthracite



Castanho
Brown



Pintado Cores RAL
Painted RAL Colours

Outros Acabamentos Other Finishes



Ver páginas 232-236
View pages 232-236

PUMP TRACKS

Design SUBAramps



Largura da Pista Ciclável 120 cm
Cycle Lane Width 120 cm

Circuito Triângulo

Triangle Circuit

01142

1876x1250x100 cm ≈ 50000 kg

25 Módulos 25 Modules

Mediante Uso do Produto

Depending on Product Use

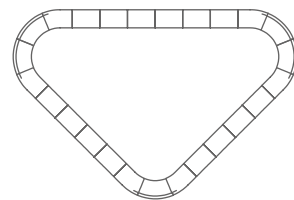

Circuito Oval Model II

Oval Circuit Model II

01163

1876x620x100 cm ≈ 44400 kg

22 Módulos 22 Modules

Mediante Uso do Produto

Depending on Product Use

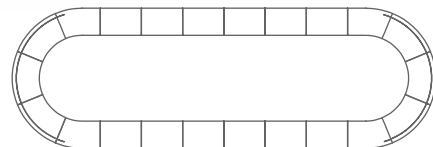

Circuito B Model II

B Circuit Model II

01164

2241x620x100 cm ≈ 59800 kg

27 Módulos 27 Modules

Mediante Uso do Produto

Depending on Product Use

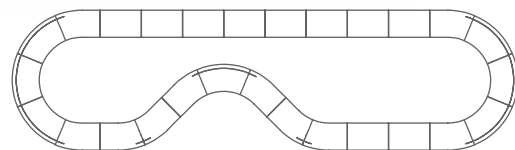



Largura da Pista Ciclável 120 cm
Cycle Lane Width 120 cm

Circuito Estrela

Star Circuit

01165

2587x2329x100 cm ≈ 120400 kg

56 Módulos 56 Modules

Mediante Uso do Produto

Depending on Product Use

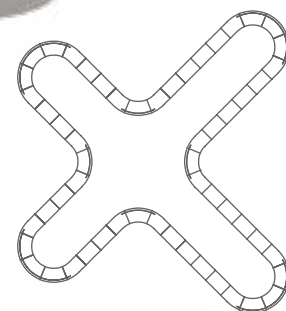

Circuito Race Model I

Race Circuit Model I

01167

3002x2106x100 cm ≈ 108400 kg

48 Módulos 48 Modules

Mediante Uso do Produto

Depending on Product Use

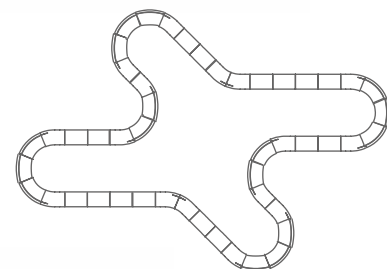

Circuito Cruz

Cross Circuit

01168

2672x2672x100 cm ≈ 108400 kg

48 Módulos 48 Modules

Mediante Uso do Produto

Depending on Product Use

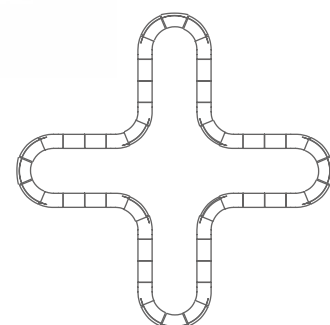

Materials Materials

Betão CS/ES
CS/ES Concrete

Acabamentos Standard Standard Finishes

Liso Pigmentado
Smooth Pigmented



Cinza
Grey



Antracite
Anthracite



Castanho
Brown



Pintado Cores RAL
Painted RAL Colours

Outros Acabamentos Other Finishes



Ver páginas 232-236
View pages 232-236

PUMP TRACKS

Design SUBAramps

Design dinâmico, inteligente e modular, circuitos fáceis de instalar, seguros e inclusivos.

Resistente aos agentes atmosféricos, baixa manutenção e elevada durabilidade.

Ideal para todas as idades e praticantes de skate, BMX, patins, trotinetas...

Pista ciclável, com textura de segurança, em bujardado suave anti-derrapante.

Dynamic, intelligent and modular design, easy to install, safe and inclusive circuits.

Resistant to atmospheric agents, low maintenance and high durability.

Ideal for any age and level of skateboarding, BMX riding, inline skating, scooter riding...

Cycling lane, non-slip, softly sandblasted, with safety texture.

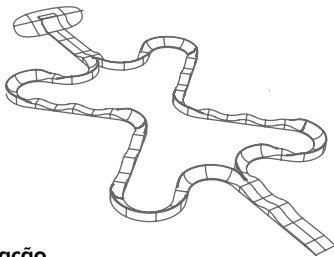

Instalação
Installation



Assentamento sobre base rígida.
Direct on rigid base.

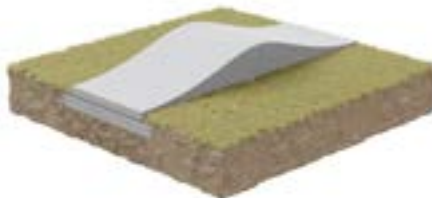

Sobre fundação em betão, acima do solo.
On concrete foundation, above the ground.

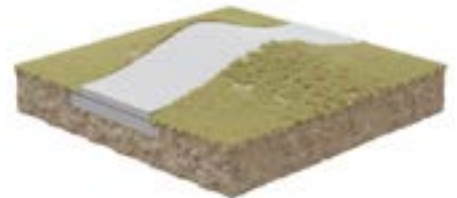

Sobre fundação em betão, ao nível do solo.
On concrete foundation, at ground level.

Sobre base flexível, consultar na ficha técnica.
On flexible base, see the technical data sheet.

SUBA
RAMPS



Amop Synergies

Módulos
Modules



Roller
Roller



Berm
Berm



Curva Esquerda
Left Curve



Curva Direita
Right Curve

Desenvolvimento de outras configurações de circuitos, abertos ou fechados.

Deverá ser validado com o Departamento Técnico de forma a evitar sequência de módulos que inviabilizem a correcta fluidez, velocidade e consequente utilização do circuito.

Como pré-concepção, nos circuitos fechados, o projectista deverá considerar um eixo de simetria no desenvolvimento do circuito, para que a pista feche regularmente.

Development of other circuit configurations, open or closed.

It must be validated with the Technical Department in order to avoid a sequence of modules that make the correct fluidity, speed and consequent use of the circuit unfeasible.

As a pre-conception, in closed circuits, the designer must consider an axis of symmetry in the development of the circuit, so that the track closes regularly.

MINI RAMPS

Design SUBAramps



MINI RAMPS

Design SUBAramps



Mini Ramp 110 Short

Mini Ramp 110 Short

01293

824x220x210 cm ≈ 6668 kg

3 Módulos 3 Modules

Mediante Uso do Produto

Depending on Product Use

Guarda de Segurança
Security Guard

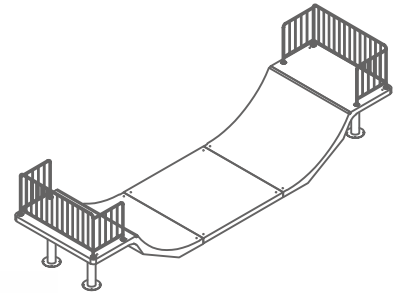

Mini Ramp 110

Mini Ramp 110

01290

824x440x210 cm ≈ 13336 kg

6 Módulos 6 Modules

Mediante Uso do Produto

Depending on Product Use

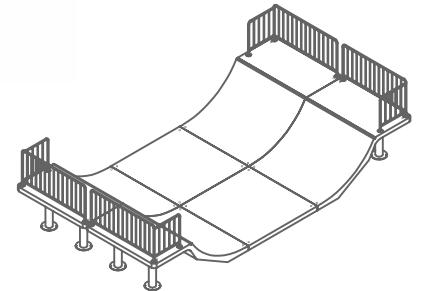

Mini Ramp 110 Wide

Mini Ramp 110 Wide

01294

824x660x210 cm ≈ 20004 kg

9 Módulos 9 Modules

Mediante Uso do Produto

Depending on Product Use

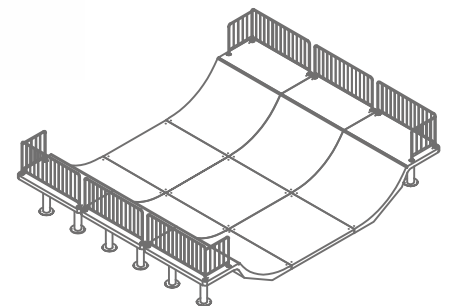



Mini Ramp 140

Mini Ramp 140

01292

824x440x240 cm ≈ 13924 kg

6 Módulos 6 Modules

Mediante Uso do Produto

Depending on Product Use

Guarda de Segurança
Security Guard

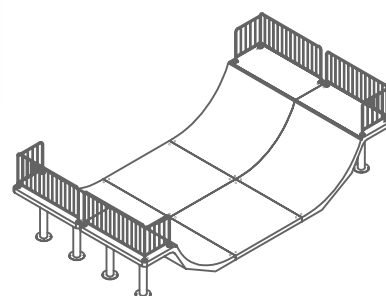

Mini Ramp 110-140

Mini Ramp 110-140

01291

824x550x240 cm ≈ 16975 kg

9 Módulos 9 Modules

Mediante Uso do Produto

Depending on Product Use

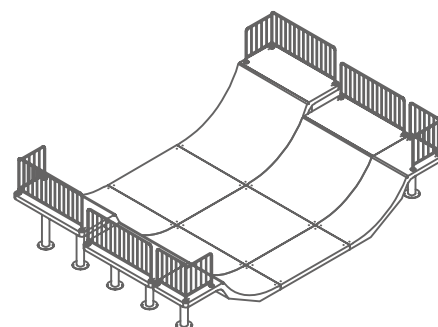

Mini Ramp 140 Wide

Mini Ramp 140 Wide

01295

824x660x240 cm ≈ 20886 kg

9 Módulos 9 Modules

Mediante Uso do Produto

Depending on Product Use

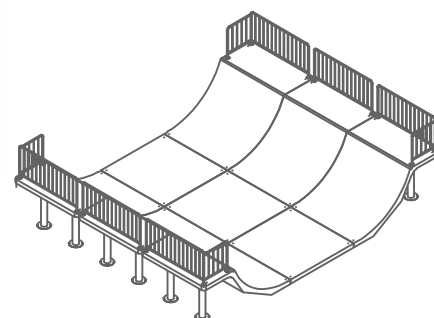

Materiais Materials

Betão CS/ES
CS/ES Concrete

Acabamentos Standard Standard Finishes

Liso Pigmentado
Smooth Pigmented



Cinza
Grey



Antracite
Anthracite



Castanho
Brown



Pintado Cores RAL
Painted RAL Colours

Outros Acabamentos Other Finishes



Ver páginas 232-236
View pages 232-236

MINI RAMPS

Design SUBAramps



Mini Ramp 110-140 Wide

Mini Ramp 110-140 Wide

01296

824x880x240 cm ≈ 27260 kg

12 Módulos 12 Modules

Mediante Uso do Produto

Depending on Product Use

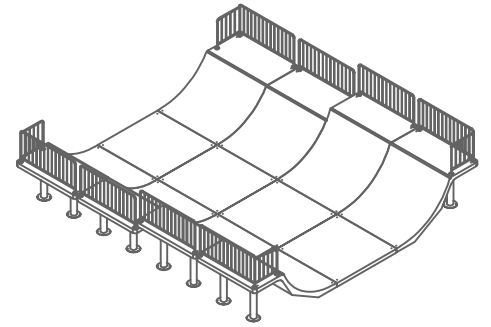

Guarda de Segurança
Security Guard

SUBA
RAMPS

MINI RAMP é um Halfpipe com dimensões coerentes, construído em betão pré-fabricado, ideal para qualquer idade e nível de praticantes de skate, BMX, patins em linha, trotinete, entre outros. As dimensões e transições suaves potenciam uma aprendizagem em segurança e uma infinita variedade de manobras, que estabelecem a base para modalidade desportiva.

Rampa com um design contemporâneo em betão armado, composta por diversos módulos standard, que permite montar várias soluções lúdicas/desportivas num curto espaço de tempo e que se adaptam a cada projeto paisagístico. Ideal para espaços exteriores, sobretudo em climas mais extremos. Fácil de montar, diversão garantida.

MINI RAMP is a Halfpipe with coherent dimensions, built in prefabricated concrete, ideal for any age and level of skateboarding, BMX riding, inline skating, scooter riding, among others. Its dimensions and smooth transitions enhance a safer learning and an infinite variety of tricks, which form the basis for this sporting discipline.

Ramp with a contemporary design in reinforced concrete, made up of several standard modules, which allows you to assemble in a short time various recreational/sporting solutions, adapting them to each landscape project. Ideal for outdoor spaces, especially in extreme climates. Easy to assemble, fun guaranteed.



Instalação

Installation



Assentamento sobre base rígida.
Direct on rigid base.



Sobre fundação em betão, acima do solo.
On concrete foundation, above the ground.



Assentamento sobre base flexível.
Applying on flexible base.

WAVE RAMPS

Design SUBAramps



WAVE RAMPS

Design SUBAramps



Wave Ramp A

Wave Ramp A

01312

660x660x167 cm ≈ 14094 kg

6 Módulos 6 Modules

Mediante Uso do Produto

Depending on Product Use



Wave Ramp B

Wave Ramp B

01313

660x880x167 cm ≈ 18792 kg

8 Módulos 8 Modules

Mediante Uso do Produto

Depending on Product Use



Wave Ramp C

Wave Ramp C

01314

660x1100x167 cm ≈ 23490 kg

10 Módulos 10 Modules

Mediante Uso do Produto

Depending on Product Use

Guarda de Segurança

Security Guard

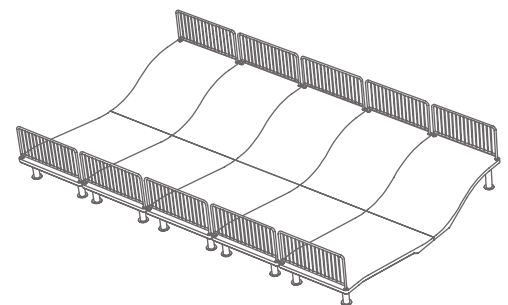
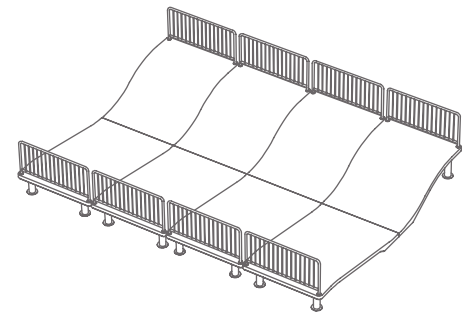
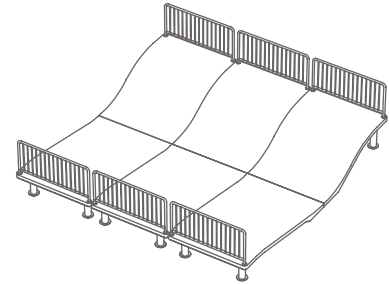

**Wave Ramp D**

Wave Ramp D

01315

660x1320x210 cm ≈ 28914 kg

12 Módulos 12 Modules

Mediante Uso do Produto

Depending on Product Use

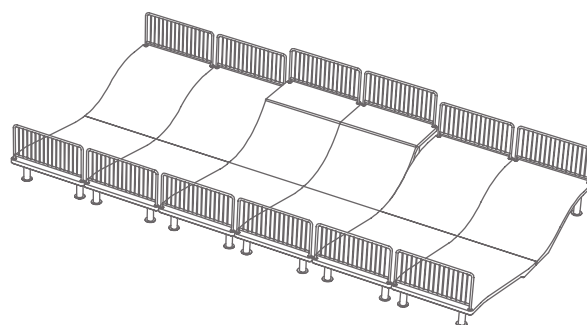
Guarda de Segurança
Security Guard**Wave Ramp E**

Wave Ramp E

01316

824x1320x210 cm ≈ 37104 kg

18 Módulos 18 Modules

Mediante Uso do Produto

Depending on Product Use

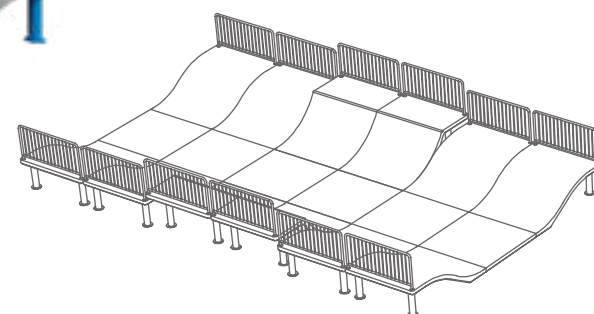
**Desenvolvimento de parques**

Deverá ser validado com o Departamento Técnico de forma a garantir a fluidez, velocidade e segurança necessárias à utilização do parque.

Como pré-conceção, nos parques deverá considerar-se o alinhamento do piso à cota das rampas.

Park development

It must be validated with the Technical Department in order to guarantee the fluidity, speed and safety necessary for using the park.

As a pre-design, in parks, the alignment of the floor to the level of the ramps should be considered.

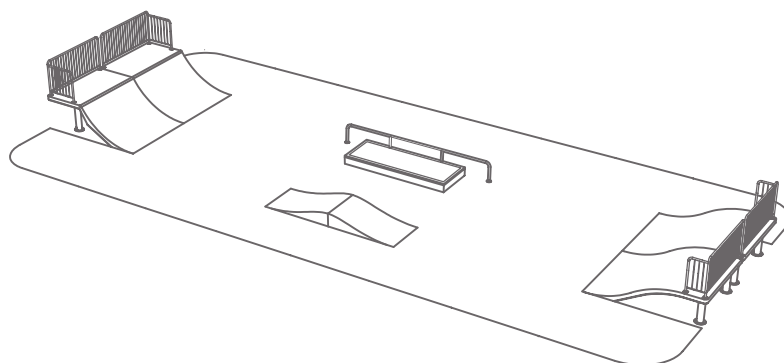
**Materiais Materials**

Betão CS/ES
CS/ES Concrete

Acabamentos Standard Standard Finishes

Liso Pigmentado
Smooth Pigmented



Cinza
Grey



Antracite
Anthracite



Castanho
Brown



Pintado Cores RAL
Painted RAL Colours

Outros Acabamentos Other Finishes

Ver páginas 232-236
View pages 232-236

WAVE RAMPS

Design SUBAramps



WAVE RAMP é um conceito concebido para a utilização de SurfSkate, composta por um lado superior a simular uma onda real e um lado inferior a imitar uma onda quebrada. Foi concebida em conjunto com a nossa equipa de design da SUBAramps e os nossos parceiros e praticantes de surfskate e surfistas.

WAVE RAMP concept is designed for SurfSkate use, composed of an upper side simulating a real wave and a lower side imitating a broken wave. It was designed together with our SUBAramps design team and our partners and surfskate and surfboards.

Instalação Installation



Assentamento sobre base rígida.
Direct on rigid base.



Sobre fundação em betão, acima do solo.
On concrete foundation, above the ground.



Assentamento sobre base flexível.
Applying on flexible base.

PARKLETS

Design Amop



Linha Modular
Modular Line



Linha Mul
Mul Line

PARKLETS

Design Amop

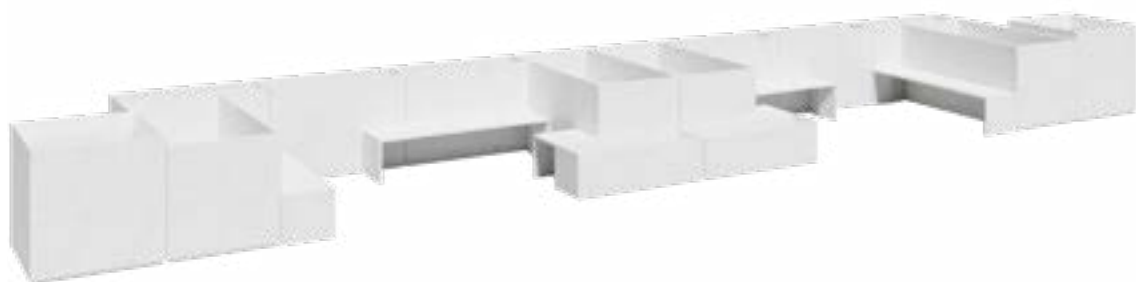

Quantificação dos Elementos

Elements Quantification

01 - Banco Individual R-Light (2 un.)

01 - Individual Bench R-Light (2 un.)

02 - Floreira Retangular Alta R-Light (6 un.)

02 - High Rectangular Planter R-Light (6 un.)

03 - Floreira Quadrada Grande R-Light (2 un.)

03 - Large Square Planter R-Light (2 un.)

04 - Floreira Retangular Grande R-Light (4 un.)

04 - Large Rectangular Planter R-Light (4 un.)

05 - Banco Coletivo R-Light (2 un.)

05 - Collective Bench R-Light (2 un.)

Configurações sob consulta

Settings upon request

Ilhas Pequenas - Small Islands

Ilhas Médias - Medium Islands

Ilhas Grandes - Big Islands

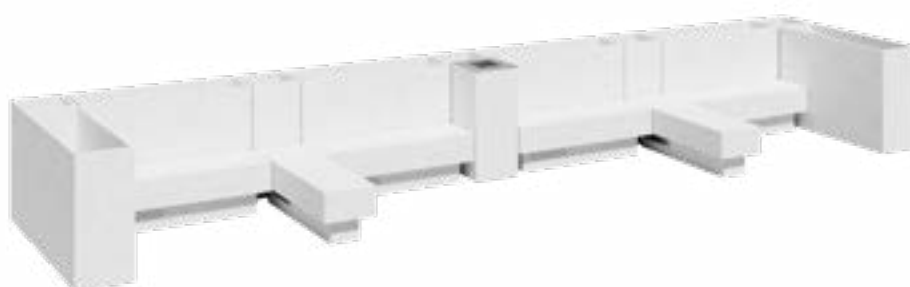

Quantificação dos Elementos

Elements Quantification

01 - Floreira Quadrada Alta R-Light (5 un.)

01 - High Square Planter R-Light (5 un.)

02 - Floreira Retangular Alta R-Light (6 un.)

02 - High Rectangular Planter R-Light (6 un.)

03 - Módulo MVC com Pé-instalação para LED (6 un.)

03 - MVC Module with LED Pre-installation (6 un.)

04 - Papeleira Citizen 20 lt (1 un.)/Papeleira Quadrada Alta R-Light (1 un.)

04 - Citizen Bin 20 lt (1 un.)/High Square Bin R-Light (1 un.)

Configurações sob consulta

Settings upon request

Ilhas Pequenas - Small Islands

Ilhas Médias - Medium Islands

Ilhas Grandes - Big Islands





PRIVATE

CARACTERÍSTICAS

Design de Mobiliário e Decoração.

Peças em betão, metal e outros materiais nobres.

Especialmente adequados, pela diferenciação estética aliada à elevada resistência, estabilidade e baixa manutenção.

FEATURES

Furniture Design and Decoration.

Equipment in concrete, metal and other noble materials.

Difference in esthetic combined with high resistance, stability and low maintenance.

APLICAÇÕES

Interior e Exterior, Uso Doméstico e Hotelaria, Espaços culturais, Espaços comerciais.

APPLICATIONS

Inddoors and Outdoors, Domestic and Hospitality Use, Cultural Spaces, Commercial spaces.

ROUND UP

Design Magda Alves Pereira

▼ Espessura Reduzida
▲ Reduced Thickness



Mesa Concrete Steel
Concrete Steel Table
30002
Ø 140x75 cm ≈ 115 kg
Aparafusamento de Superfície
Surface Bolted Anchoring/
Simplesmente Apoiado Self Standing



Mesa Concrete Wood
Concrete Wood Table
30001
Ø 140x75 cm ≈ 135 kg
Aparafusamento de Superfície
Surface Bolted Anchoring/
Simplesmente Apoiado Self Standing

**Mesa Bar A**

Bar Table A

28001

Ø 80x110 cm ≈ 65 kg

Aparafusamento de Superfície / Surface Bolted Anchoring/
Simplesmente Apoiado / Self Standing**Mesa Bar B**

Bar Table B

28010

Ø 80x110 cm ≈ 65 kg Ø 16 cm Furo / Hole

Aparafusamento de Superfície / Surface Bolted Anchoring/
Simplesmente Apoiado / Self Standing**Mesa A**

Table A

28002

Ø 140x76 cm ≈ 120 kg

Aparafusamento de Superfície / Surface Bolted Anchoring/
Simplesmente Apoiado / Self Standing**Mesa B**

Table B

28003

Ø 140x76 cm ≈ 120 kg Ø 21 cm Furo / Hole

Aparafusamento de Superfície / Surface Bolted Anchoring/
Simplesmente Apoiado / Self Standing**Mesa de Apoio A**

Side Table A

28004

Ø 80x45 cm ≈ 45 kg

Aparafusamento de Superfície / Surface Bolted Anchoring/
Simplesmente Apoiado / Self Standing**Mesa de Apoio B**

Side Table B

28005

Ø 80x45 cm ≈ 45 kg Ø 16 cm Furo / Hole

Aparafusamento de Superfície / Surface Bolted Anchoring/
Simplesmente Apoiado / Self Standing**Materiais / Materials**Betão UHPC
UHPC ConcreteAço Metalizado Pintado
Painted Metallized Steel**Acabamentos Standard / Standard Finishes**Liso Pigmentado
Smooth PigmentedMadeira Termotratada
Thermo-treated WoodBranco
WhiteCinza
GreyPolido
PolishBranco
WhiteCinza
GreyBranco e Preto
White and Black**Outros Acabamentos / Other Finishes**Ver páginas 230-231 | 225
View pages 230-231 | 225

SCREEN

Design Amop



Floreira Vedação 1PL
 Planter Fence
 34003
 115x35x132 cm ≈ 150 kg
 Aparafusamento de Superfície
 Surface Bolted Anchoring/
 Simplesmente Apoiado Self Standing



Vedação 1PL
 Fence 1PL
 34002
 115x30x132 cm ≈ 120 kg
 Aparafusamento de Superfície
 Surface Bolted Anchoring/
 Simplesmente Apoiado Self Standing



Floreira 1
 Planter 1
 34001
 115x35x42 cm ≈ 130 kg
 Aparafusamento de Superfície
 Surface Bolted Anchoring/
 Simplesmente Apoiado Self Standing

**Banco Individual 3A***Individual Bench 3A*

34011

50x50x45 cm ≈ 19 kg

Aparafusamento de Superfície *Surface Bolted Anchoring/*Simplesmente Apoiado *Self Standing*Sistema de Apoio Regulável *Adjustable Support System***Cadeira Individual 3A***Individual Chair 3A*

34013

50x55x85 cm ≈ 29 kg

Aparafusamento de Superfície *Surface Bolted Anchoring/*Simplesmente Apoiado *Self Standing*Sistema de Apoio Regulável *Adjustable Support System***Mesa Picnic 80A***Picnic 80A*

34016

80x80x80 cm ≈ 33 kg

Aparafusamento de Superfície *Surface Bolted Anchoring/*Simplesmente Apoiado *Self Standing*Sistema de Apoio Regulável *Adjustable Support System***Banco Coletivo 3A***Collective Bench 3A*

34012

180x50x45 cm ≈ 36 kg

Aparafusamento de Superfície *Surface Bolted Anchoring/*Simplesmente Apoiado *Self Standing*Sistema de Apoio Regulável *Adjustable Support System***Cadeira Coletiva 3A***Collective Chair 3A*

34014

180x55x85 cm ≈ 59 kg

Aparafusamento de Superfície *Surface Bolted Anchoring/*Simplesmente Apoiado *Self Standing*Sistema de Apoio Regulável *Adjustable Support System***Mesa Picnic 180A***Picnic Table 180A*

34015

180x80x80 cm ≈ 60 kg

Aparafusamento de Superfície *Surface Bolted Anchoring/*Simplesmente Apoiado *Self Standing*Sistema de Apoio Regulável *Adjustable Support System***Materiais Materials**Aço Metalizado Pintado
*Painted Metallized Steel*Plástico Reciclado
*Recycled Plastic*Opção: Madeira Termotratada
*Option: Thermo-treated Wood***Acabamentos Standard Standard Finishes**
 Antracite Micro Texturado
Micro Textured Anthracite
Betão CS/ES: Liso Pigmentado
CS/ES Concrete: Smooth Pigmented
 Cinza
Grey
Outros Acabamentos Other Finishes
 Ver páginas 225
View pages 225

SCREEN

Design Amop



Conj. Picnic 4P

Picnic Set 4P

34023

220x220x80 cm ≈ 109 kg

Aparafusamento de Superfície / Surface Bolted Anchoring/

Simplemente Apoiado / Self Standing

Sistema de Apoio Regulável / Adjustable Support System



Conj. Picnic 4P Encosto

Picnic Set 4P with Backrest

34024

231x231x85 cm ≈ 149 kg

Aparafusamento de Superfície / Surface Bolted Anchoring/

Simplemente Apoiado / Self Standing

Sistema de Apoio Regulável / Adjustable Support System



Conj. Picnic 6P

Picnic Set 6P

34025

180x220x80 cm ≈ 132 kg

Aparafusamento de Superfície / Surface Bolted Anchoring/

Simplemente Apoiado / Self Standing

Sistema de Apoio Regulável / Adjustable Support System



Conj. Picnic 6P Encosto

Picnic Set 6P with Backrest

34026

180x231x85 cm ≈ 178 kg

Aparafusamento de Superfície / Surface Bolted Anchoring/

Simplemente Apoiado / Self Standing

Sistema de Apoio Regulável / Adjustable Support System



Conj. Picnic 8P

Picnic Set 8P

34027

320x220x80 cm ≈ 170 kg

Aparafusamento de Superfície / Surface Bolted Anchoring/

Simplemente Apoiado / Self Standing

Sistema de Apoio Regulável / Adjustable Support System



Conj. Picnic 8P Encosto

Picnic Set 8P With Backrest

34028

331x231x85 cm ≈ 236 kg

Aparafusamento de Superfície / Surface Bolted Anchoring/

Simplemente Apoiado / Self Standing

Sistema de Apoio Regulável / Adjustable Support System

Materials / Materials

Aço Metalizado Pintado
Painted Metallized Steel

Plástico Reciclado
Recycled Plastic

Opção: Madeira Termotratada
Option: Thermo-treated Wood

Acabamentos Standard / Standard Finishes

Antracite Micro Texturado
Micro Textured Anthracite

Betão CS/ES: Liso Pigmentado
CS/ES Concrete: Smooth Pigmented

Outros Acabamentos / Other Finishes

RE-CYCLE Ver páginas 225
View pages 225

Cinza
Grey

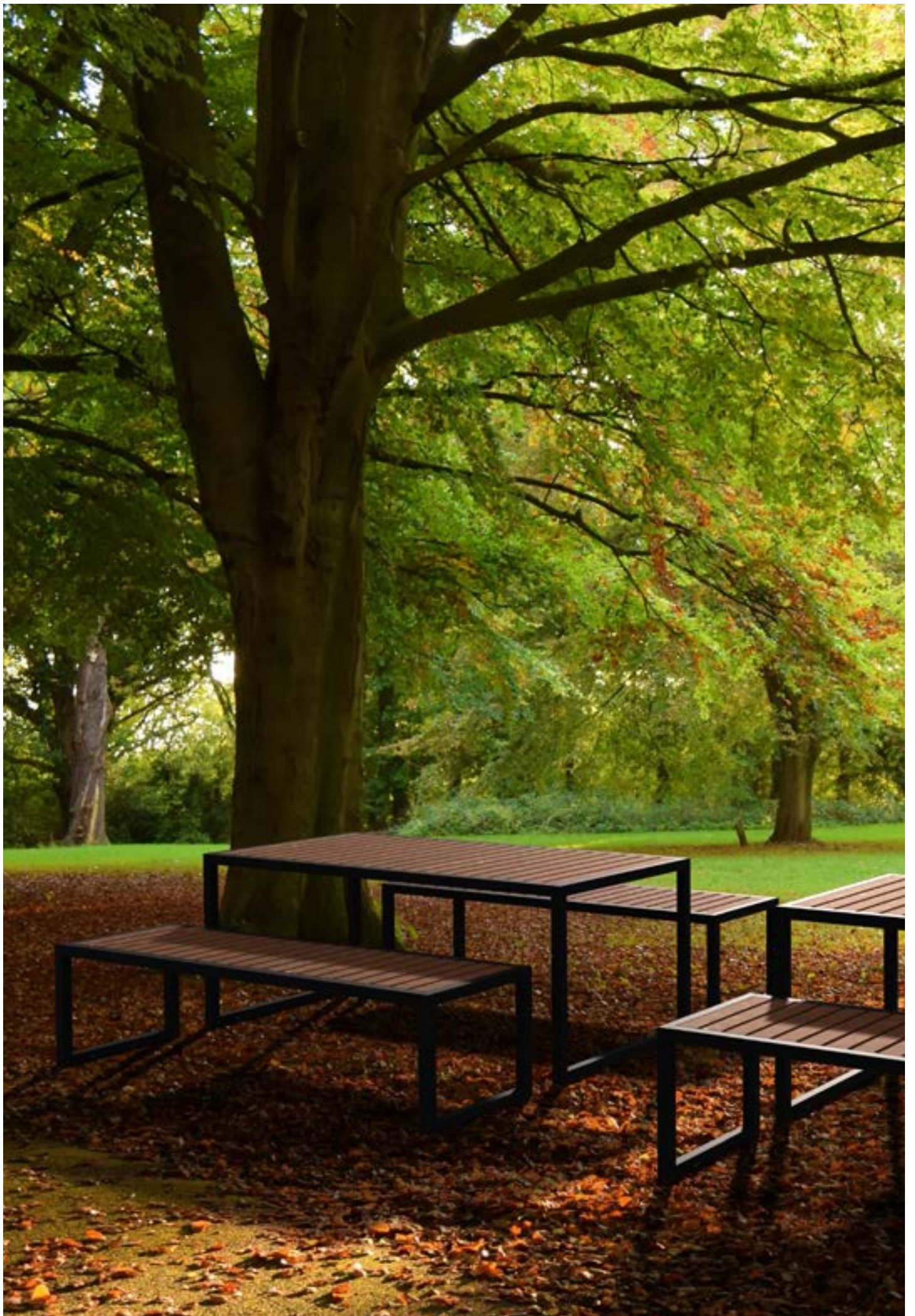

SCREEN

Design Amop



Banco Bar Individual 3A

Individual Bar Bench 3A

34035

50x50x77 cm ≈ 26 kg

Aparafusamento de Superfície

Surface Bolted Anchoring/

Simplesmente Apoiado Self Standing

Sistema de Apoio Regulável

Adjustable Support System



Cadeira Bar Individual 3A

Individual Bar Chair 3A

34036

50x50x97 cm ≈ 31 kg

Aparafusamento de Superfície

Surface Bolted Anchoring/

Simplesmente Apoiado Self Standing

Sistema de Apoio Regulável

Adjustable Support System



Chaise Longue 3A

Chaise Longue 3A

34051

151x60x81 cm ≈ 68 kg

Aparafusamento de Superfície

Surface Bolted Anchoring/

Simplesmente Apoiado Self Standing

Sistema de Apoio Regulável

Adjustable Support System

**Mesa Bar 80A***Bar Table 80A*

34037

80x80x110 cm ≈ 47 kg

Aparafusamento de Superfície *Surface Bolted Anchoring/*Simplesmente Apoiado *Self Standing*Sistema de Apoio Regulável *Adjustable Support System***Mesa Bar 180A***Bar Table 80A*

34038

180x80x110 cm ≈ 76 kg

Aparafusamento de Superfície *Surface Bolted Anchoring/*Simplesmente Apoiado *Self Standing*Sistema de Apoio Regulável *Adjustable Support System***Conjunto Bar 4P***Bar Ser 4P*

34043

220x220x110 cm ≈ 153 kg

Aparafusamento de Superfície *Surface Bolted Anchoring/*Simplesmente Apoiado *Self Standing*Sistema de Apoio Regulável *Adjustable Support System***Conjunto Bar 4P Encosto***Bar Set 4P with Backrest*

34044

225x225x110 cm ≈ 171 kg

Aparafusamento de Superfície *Surface Bolted Anchoring/*Simplesmente Apoiado *Self Standing*Sistema de Apoio Regulável *Adjustable Support System***Conjunto Bar 6P***Bar Ser 6P*

34045

180x220x110 cm ≈ 232 kg

Aparafusamento de Superfície *Surface Bolted Anchoring/*Simplesmente Apoiado *Self Standing*Sistema de Apoio Regulável *Adjustable Support System***Conjunto Bar 6P Encosto***Bar Set 6P with Backrest*

34046

180x225x110 cm ≈ 262 kg

Aparafusamento de Superfície *Surface Bolted Anchoring/*Simplesmente Apoiado *Self Standing*Sistema de Apoio Regulável *Adjustable Support System***Materiais Materials**Aço Metalizado Pintado
*Painted Metallized Steel*Plástico Reciclado
*Recycled Plastic*Opção: Madeira Termotratada
*Option: Thermo-treated Wood***Acabamentos Standard Standard Finishes**
 Antracite Micro Texturado
Micro Textured Anthracite
Betão CS/ES: Liso Pigmentado
CS/ES Concrete: Smooth Pigmented
 Cinza
Grey
Outros Acabamentos Other Finishes
 **RE-CYCLE** Ver páginas 225
View pages 225

FLOW

Design João Seco

▼ Espessura Reduzida
▲ Reduced Thickness



**Chaise***Chaise*

26001

180x62x56 cm ≈ Base 85 kg Assento 75 Kg
≈ Base 85 kg Seat 75 KgSimplesmente Apoiado *Self-Standing***Lounge***Lounge*

26002

91x62x88 cm ≈ Base 80 kg Assento 50 Kg
≈ Base 80 kg Seat 50 KgSimplesmente Apoiado *Self-Standing***Minimal Chaise***Minimal Chaise*

26005

180x62x49 cm ≈ 100 kg

Simplesmente Apoiado *Self-Standing***In-Pool / Out-Pool**Modelo para aplicação dentro e fora da piscina
In and Out pool application model**Mesa Chaise***Chaise Table*

26004

74x31x17 cm ≈ 20 kg

Simplesmente Apoiado *Self-Standing***Mesa Lounge***Lounge Table*

26003

80x31x38 cm ≈ 25 kg

Simplesmente Apoiado *Self-Standing***Materiais Materials**Betão UHPC
*UHPC Concrete***Acabamentos Standard Standard Finishes**Liso Pigmentado
Smooth PigmentedBranco
WhiteCinza
*Grey*Bujardado Suave
SandblastedBranco
WhiteCinza
*Grey***Outros Acabamentos Other Finishes**Ver páginas 230-231
View pages 230-231Liso Pintado Cores RAL
Smooth Painted RAL Colours

MEGA LAJETAS

Design Amop



Mega Lajeta
Mega-Paving Flag
≈ 150Kg/m²

	C cm	L cm	E cm
12001	50	50	6
12002	100	25	6
12003	100	50	6
12004	120	80	6
12005	100	100	6
12019	140	70	6
12006	140	100	6

Outras medidas disponíveis por encomenda.
Other measures available on request.

Materials Materials

Beirão CS/ES
CS/ES Concrete

Acabamentos Standard Standard Finishes

Liso Pigmentado
Smooth Pigmented

● Branco
White

● Cinza
Grey

Bujardado
Shot Blasted

● Pedra Lioz
Lioz Stone

● Granito Azul
Blue Granite

Outros Acabamentos Other Finishes

Ver páginas 234-236
View pages 234-236

Amop Synergies

Bujardado Suave
Sandblasted

● Branco
White

● Cinza
Grey

LAREIRA

Design Amop



Lareira Dafoz

Dafoz Fire Pit

33003

100x100x10 cm ≈ 130 kg

Simplemente Apoiado *Self-Standing*

Inclui Queimador em Aço Corten *Corten Steel Burner Included*

DEGRAU

Design Amop



Acessibilidades

Aresta à Vista Boleada.
Faixa Anti-derrapante e
de Sinalização Visual
Sob Consulta.

Accessibilities

Visible Round Edge.
Visible Anti Slip.
Signaling Stripe on Request.

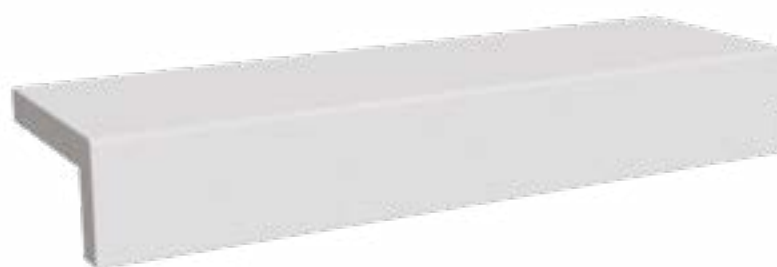

Degrau com Espelho

Step with Riser

18026

120x34x17,3 cm ≈ 70 kg/ml

Materiais *Materials*

Betão CS/ES
CS/ES Concrete

Acabamentos Standard *Standard Finishes*

Liso Pigmentado
Smooth Pigmented



Branco
White



Cinza
Grey

Bujardado
Shot Blasted



Pedra Lioz
Lioz Stone



Granito Azul
Blue Granite

Bujardado Suave
Sandblasted



Branco
White



Cinza
Grey

Outros Acabamentos *Other Finishes*

Ver páginas 234-236
View pages 234-236

SALINAS

Design TIP Architects / Sílvia Figueira / Marta Corvo



Mega Lajeta Salinas
Salinas Mega-Paving Flag
33004
≈ 148 Kg/m²

	C cm	L cm	E cm
33004	141,4	102,4	6

Materials Materials

Betão CS/ES
CS/ES Concrete

Acabamentos Standard Standard Finishes

Liso Pigmentado
Smooth Pigmented



Branco
White



Cinza
Grey

Bujardado
Shot Blasted



Pedra Lioz
Lioz Stone



Granito Azul
Blue Granite

Outros Acabamentos Other Finishes

Ver páginas 234-236
View pages 234-236

ORIGAMI

Design AMOP



Lareira Origami

Origami Fire Pit

Model I 60

Model I 60

33005

63x63x20 cm ≈ 10 kg

Model I 80

Model I 80

33006

82x82x20 cm ≈ 15 kg

Model I 120

Model I 120

33009

121x121x20 cm ≈ 32 kg

Simplemente Apoiado Self-Standing



Lareira Origami

Origami Fire Pit

Model II 60

Model II 60

33007

60x60x20 cm ≈ 16 kg

Model II 80

Model II 80

33008

80x80x20 cm ≈ 22 kg

Model II 120

Model II 120

33010

120x120x20 cm ≈ 40 kg

Simplemente Apoiado Self-Standing

Materials Materials

Aço Corten Natural
Natural Corten Steel



MONO K

CARACTERÍSTICAS

Pedra Reconstituída
Revestimentos em pedra natural
reconstituída. Soluções técnicas
económicas.

Baixa absorção de água <3%.
Elevada resistência, baixa
espessura.

FEATURES

*Reconstituted Stone
Coverings in reconstituted
natural stone, authentic
finishing, economic and
technical solutions.
Low water absorption <3%.
High resistance, low thickness.*

APLICAÇÕES

Interior e Exterior, Pavimentos
e Revestimentos, Coberturas
Planas, Bordaduras de Piscinas

APPLICATIONS

*Indoors and Outdoors, Pavements
and Coverings, Flat Coverings,
Pool Borders*

DISTINTUS ACETINADO

Distintus Brushed



Superfície meio brilho, tipo Terrazzo
Brushed surface, medium shine, Terrazzo type

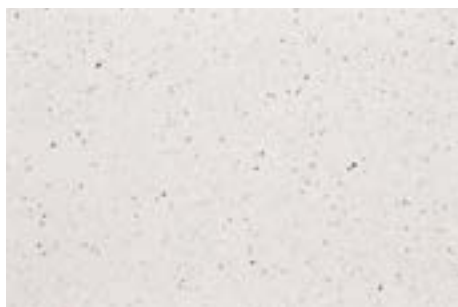

Branco Dunas Acetinado
Dunas White Brushed
 MDJ4020101



Granito Real Acetinado
Royal Granite Brushed
 MDJ4020110



Granito Beirão Acetinado
Beirão Granite Brushed
 MDJ4020111

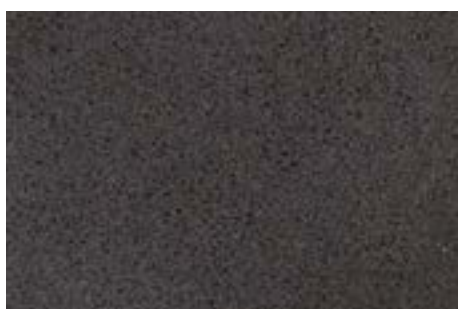

Negro Fráguas Acetinado
Fráguas Black Brushed
 MDJ4020102

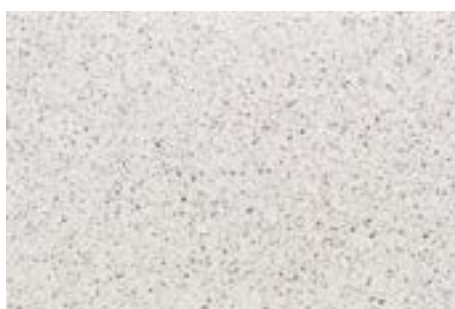

Pedras Salgadas Acetinado
Pedras Salgadas Brushed
 MDJ4020115

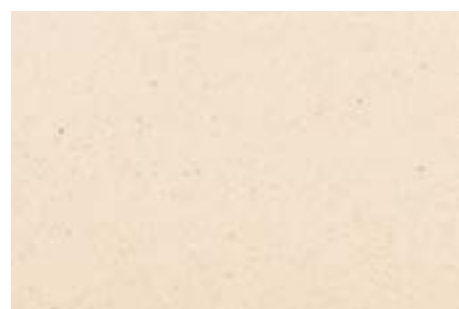

Creme Acetinado
Cream Brushed
 MDJ4020124



Amarelo Negrais Acetinado
Negrais Yellow Brushed
 MDJ4020114

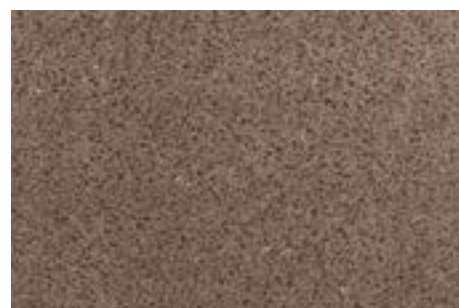

Castanho Escuro Acetinado
Dark Brown Brushed
 MDJ4020123

Outras Estereotomias *Other Estereotomies*

DISTINTUS DESBASTADO

Distintus Honed

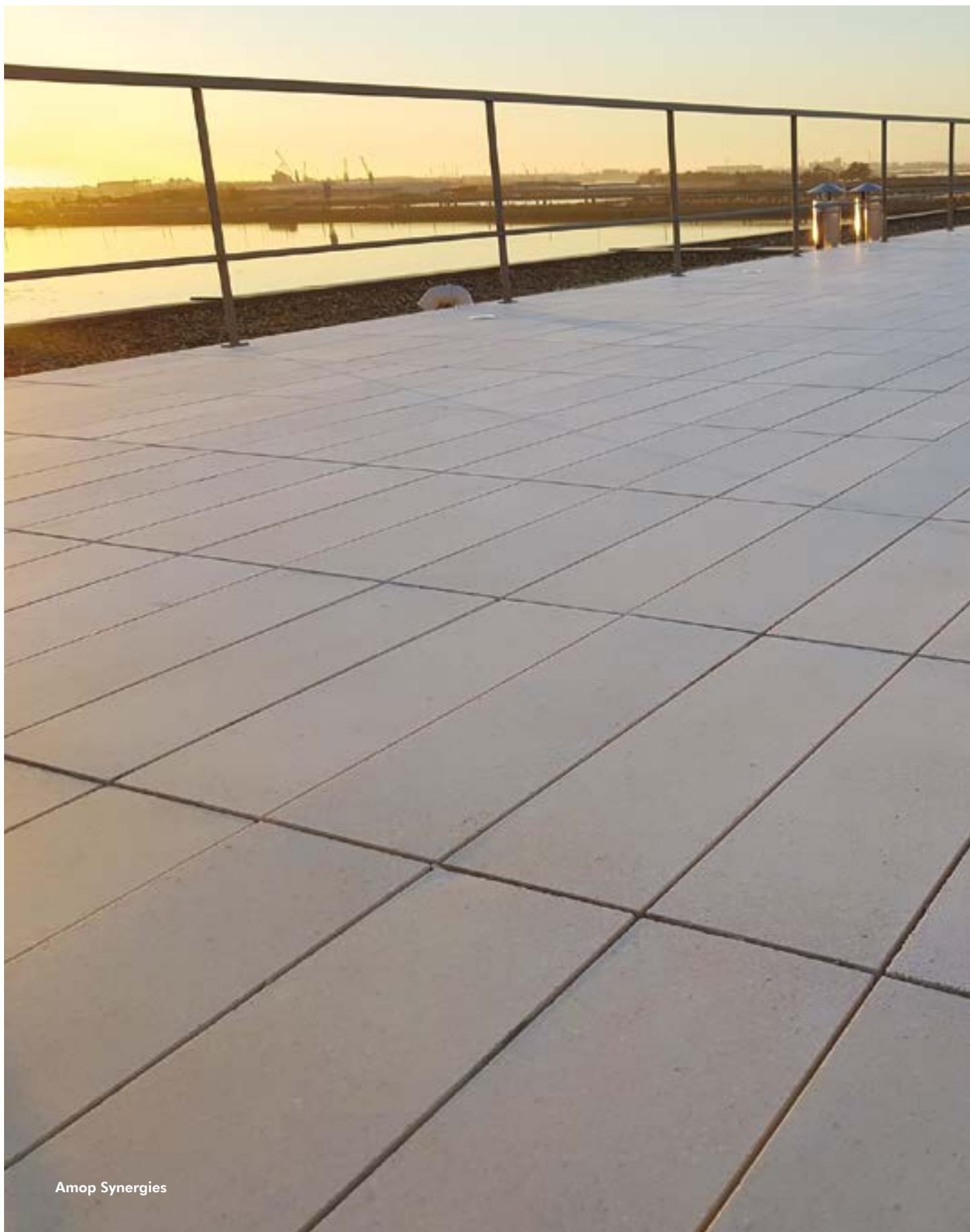

Superfície desbastada mate, tipo pedra serrada
Matte rough surface, medium shine, sawn stone type

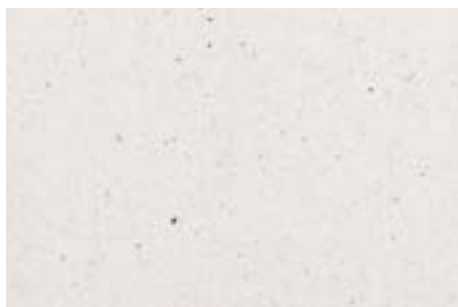

Branco Dunas Desbastado
Dunas White Honed
 MDJ1020101



Granito Real Desbastado
Royal Granite Honed
 MDJ1020110



Granito Beirão Desbastado
Beirão Granite Honed
 MDJ1020111



Negro Fráguas Desbastado
Fráguas Black Honed
 MDJ1020102

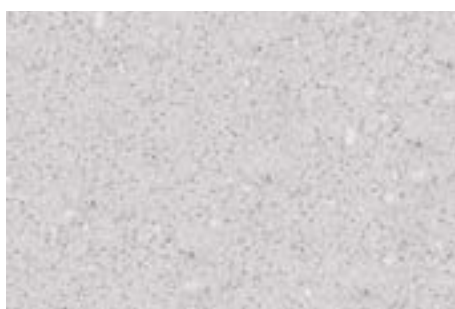

Pedras Salgadas Desbastado
Pedras Salgadas Honed
 MDJ1020115

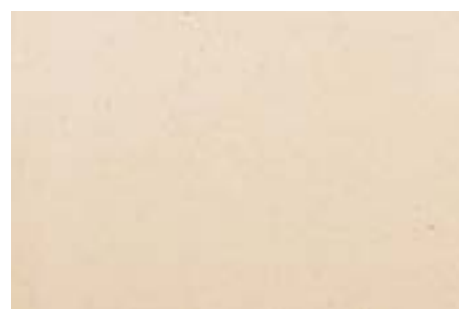

Creme Desbastado
Cream Honed
 MDJ1020124

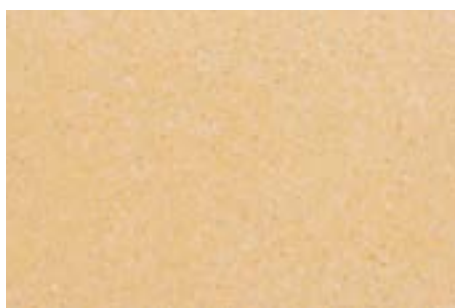

Amarelo Negrais Desbastado
Negrais Yellow Honed
 MDJ1020114



Castanho Escuro Desbastado
Dark Brown Honed
 MDJ1020123

Outras Estereotomias *Other Estereotomies*

ESTILHADUS

Estilhadus



Superfície bujardada forte
Strong sandblasted surface

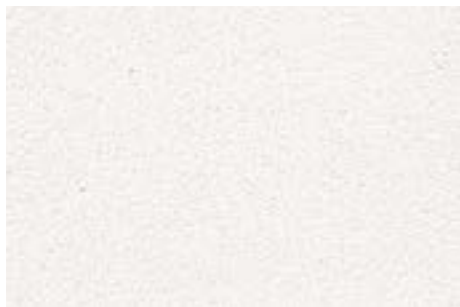

Estilhadus Branco Dunas
Estilhadus Dunas White
 MDJ2020301



Estilhadus Granito Real
Estilhadus Royal Granite
 MDJ2020310



Estilhadus Granito beirão
Estilhadus Beirão Granite
 MDJ2020311



Estilhadus Negro Fráguas
Estilhadus Fráguas Black
 MDJ2020302

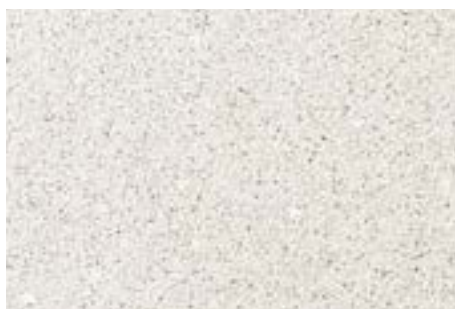

Estilhadus Pedras Salgadas
Estilhadus Pedras Salgadas
 MDJ2020315

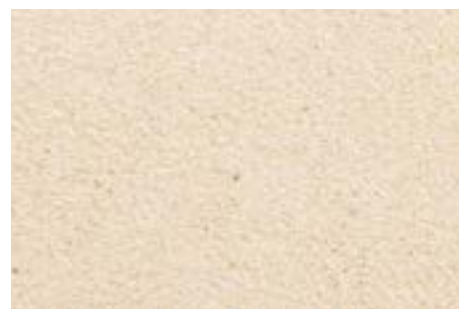

Estilhadus Creme
Estilhadus Cream
 MDJ2020324

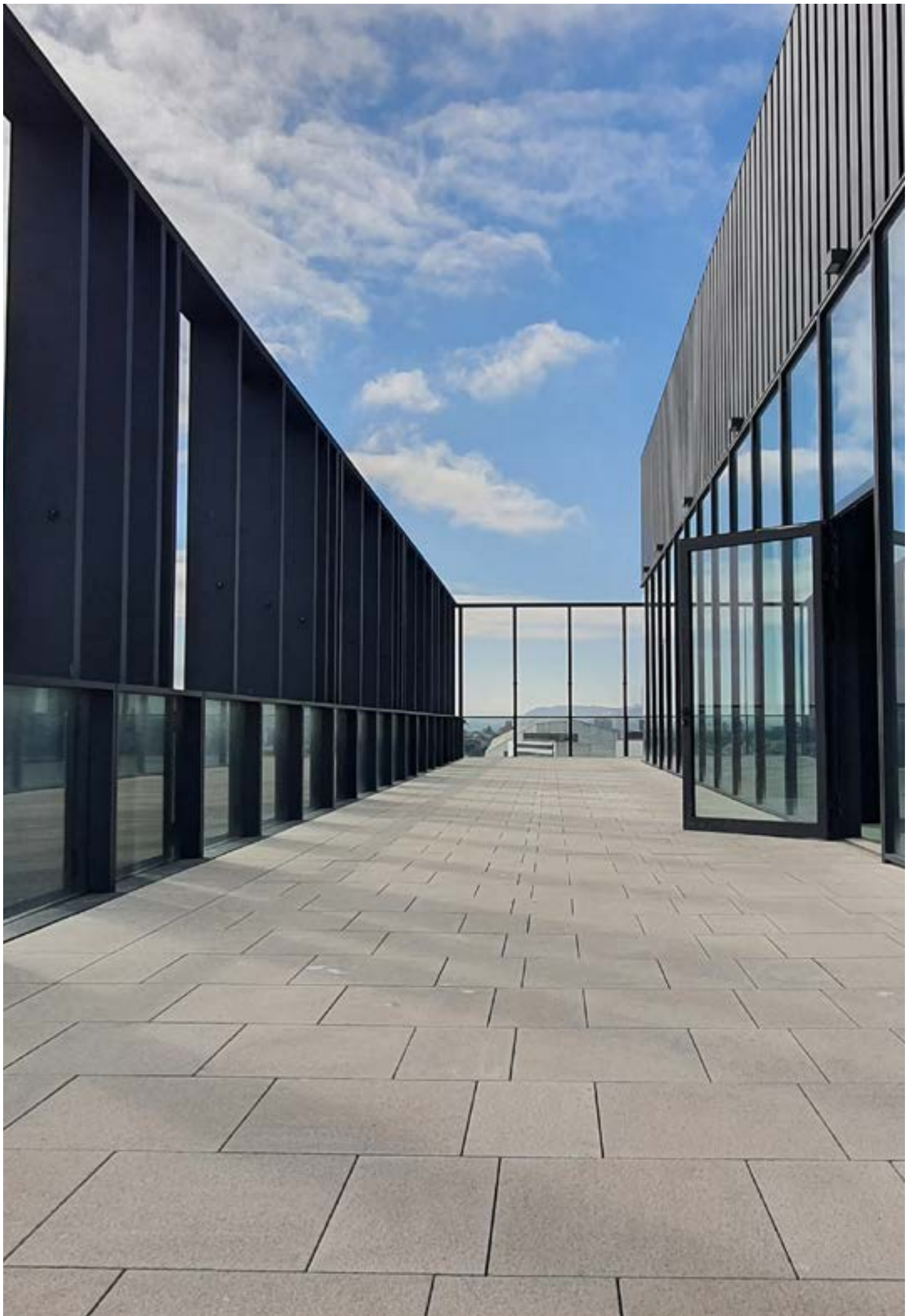

Superfície desbastada mate ou bujardada forte
Matte rough surface or strong sandblasted surface

TIRA
Strip



Tira Estilhadus
Estilhadus Strip

58x7x2,5cm \approx 62 kg/m²



Tira Desbastado
Honed Strip

58x7x2,5cm \approx 62 kg/m²



Tira Estilhadus
Estilhadus Strip

58x9x2,5cm \approx 62 kg/m²



Tira Desbastado
Honed Strip

58x9x2,5cm \approx 62 kg/m²

Arestas Serradas Sawn Edges

Disponível em todas as cores do DESBASTADO, ESTILHADUS.
Available in all colors of HONED, ESTILHADUS.

DIAGONAL

Design Amop

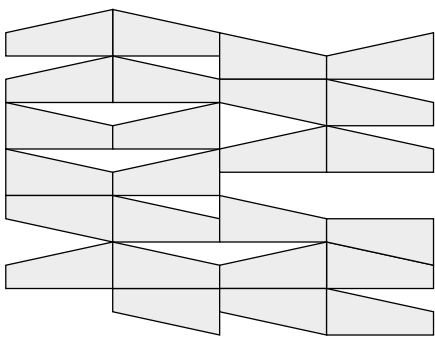

1.

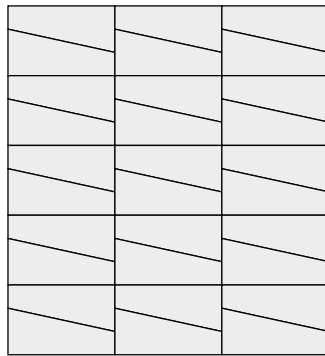

2.

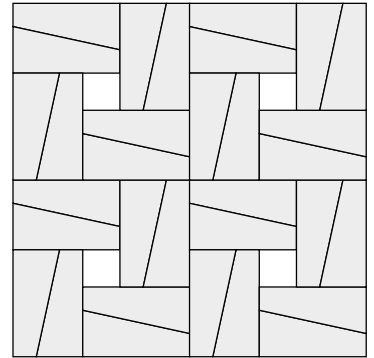

3.

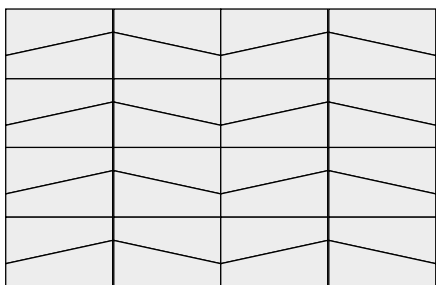

4.

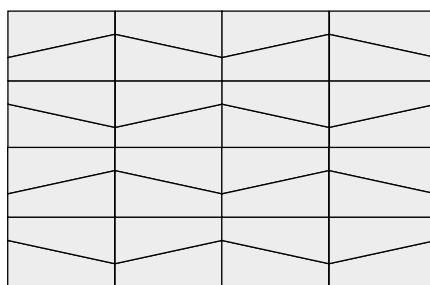

5.

Peça Direita
Right Slab



Peça Esquerda
Left Slab





Branco Dunas Besbastado
White Dunas Honed
 MDJ1020101D1582525
 58x25,33cm ≈ / 12,67x2,5 cm ≈ 62 kg/m²



Granito Real Desbastado
Royal Granite Honed
 MDJ1020110D1582525
 58x25,33cm ≈ / 12,67x2,5 cm ≈ 62 kg/m²



Negro Fráguas Desbastado
Black Fráguas Honed
 MDJ1020102D1582525
 58x25,33cm ≈ / 12,67x2,5 cm ≈ 62 kg/m²



Granito Beirão Desbastado
Beirão Granite Honed
 MDJ1020111D1582525
 58x25,33cm ≈ / 12,67x2,5 cm ≈ 62 kg/m²

Desbastado
Honed



Estilhadus
Hammered



Estilhadus Branco Dunas
Estilhadus White Dunas
 MDJ2020301D1582525
 58x25,33cm ≈ / 12,67x2,5 cm ≈ 62 kg/m²



Estilhadus Granito Real
Estilhadus Royal Granite
 MDJ2020310D1582525
 58x25,33cm ≈ / 12,67x2,5 cm ≈ 62 kg/m²



Estilhadus Negro Fráguas
Estilhadus Black Fráguas
 MDJ2020302D1582525
 58x25,33cm ≈ / 12,67x2,5 cm ≈ 62 kg/m²



Estilhadus Granito Beirão
Estilhadus Beirão Granite
 MDJ2020311D1582525
 58x25,33cm ≈ / 12,67x2,5 cm ≈ 62 kg/m²

TIRA BETÃO

Concrete Strip

Superfície betão natural aparente
Natural apparent concrete surface



Tira Betão Branco
White Concrete Strip

MDJ2030601T



Tira Betão Cinza
Grey Concrete Strip

MDJ2030630T



Medidas disponíveis
Available measurements



56x7x2,5cm ≈ 62 kg/m²

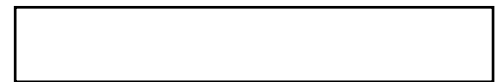

56x9x2,5cm ≈ 62 kg/m²

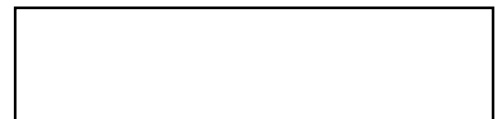

56x13,5x2,5cm ≈ 62 kg/m²



56x18,5x2,5cm ≈ 62 kg/m²

Arestas Serradas Sawn Edges

COMPLEMENTOS

Complements



Elementos de confinamento.
Guias e Caldeiras em Aço Corten.
Sob consulta.
*Confinement elements.
Guides and Tree Surrounds in Corten Steel.
Available on request.*



Pavimentos em Aço Corten.
Sob consulta.
*Corten Steel Pavements.
Available on request.*



Mobiliário em Aço Corten.
Sob consulta.
*Corten Steel Furniture.
Available on request.*

SAND_STONE

Design Amop



Superfície riscada suave

Smooth scratch surface



Branco Dunas
Dunas White
MDJ2030801



Granito Beirão
Beirão Granite
MDJ2030811



Creme
Cream
MDJ2030824

Pavimento

Floor

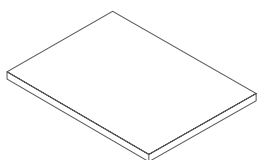

Lajeta
Slab
78x58 cm

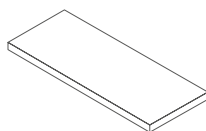

Tira
Strip
78x28 cm

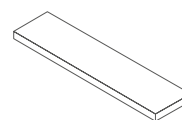

Tira
Strip
78x14 cm
78x18,5 cm

Degraus

Steps

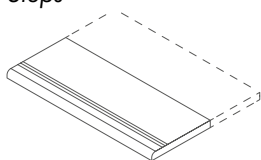

Degrau 78x(máx. 58 cm)
Step 78x(max. 58 cm)

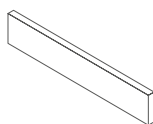

Espelho 78x14 cm
Strip 78x14 cm

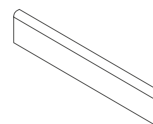

Rodapé 78x14 cm
Skirting-Board 78x14 cm

Bordaduras de Piscina

Swimming Pool Borders

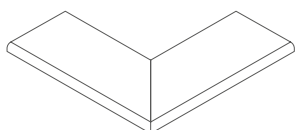

Canto Convexo (conj.) 78x78 cm
Convex Corner (Set) 78x78 cm

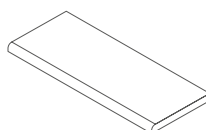

Bordadura 78x28 cm
Border 78x28 cm

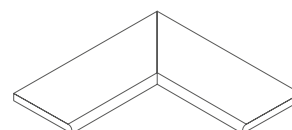

Canto Côncavo (conj.) 78x28 cm
Concave Corner (Set) 78x78 cm

Cobre-muros

Wall Cover

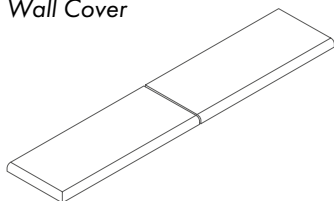

Cobre-muros 78x28 cm
Wall Cover 78x28 cm

Lajeta Eco Tech

- Eficiência em instalação de pavimentos elevados e de fachadas ventiladas
- Eficiência em instalação de pavimentos pedonais respeitando a permeabilidade do solo
- Superfície de elevado conforto e antiderrapante em seco e molhado
- De acordo com os requisitos da acessibilidade e mobilidade

Eco Tech Slab

- Efficient installation for raised floors and ventilated facades
- Efficient installation for pedestrian walkways while respecting soil permeability
- High comfort and non-slip surface in wet and dry conditions
- Compliant with accessibility and mobility requirements

Outras Estereotomias Other Estereotomies

78x58x3,5 cm / 78x28x3,5 cm ≈ 87 Kg/m²

Arestas Serradas Sawn Edges

Outras configurações por corte sob consulta
Other configurations by cut upon request

CONCRETE_STONE

Design Amop



Betão liso antiderrapante

Non-slip smooth concrete

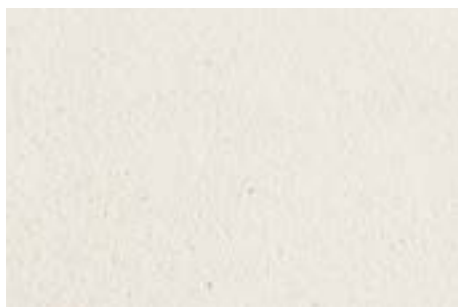

Branco
White
MDJ2030901



Cinza
Grey
MDJ2030930

Pavimento

Floor

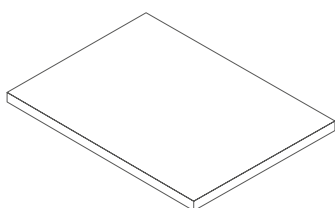

Lajeta
Slab
80x60 cm

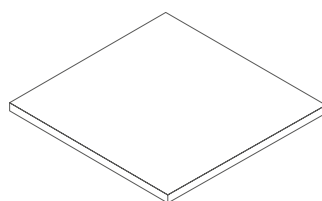

Lajeta
Slab
60x60 cm

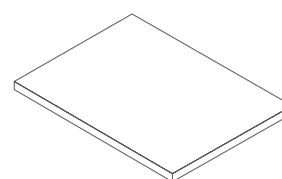

Lajeta
Slab
60x40 cm

Lajeta Eco Tech

- Textura betão liso antiderrapante
- Dimensões, espessura e formatos
- Eficiência em instalação de pavimentos elevados e de fachadas ventiladas
- Eficiência em instalação de pavimentos pedonais respeitando a permeabilidade do solo
- Superfície de elevado conforto e antiderrapante em seco e molhado
- De acordo com os requisitos da linguagem minimalista do design e arquitetura

Eco Tech Slab

- Non-slip smooth concrete texture
- Dimensions, thickness, and formats
- Efficiency in installing raised floors and ventilated facades
- Efficiency in installing pedestrian walkways while respecting soil permeability
- High comfort and non-slip surface in wet and dry conditions
- In accordance with the minimalist language of design and architecture requirements

Outras Estereotomias *Other Estereotomies*

80x60x3,7 cm / 60x60x3,7 cm / 60x40x3,5 cm ≈ 92 Kg/m²

Arestas Naturais *Natural Edges*

Outras configurações por corte sob consulta
Other configurations by cut upon request



PASSEIOS PÁTIOS PISCINAS

*SIDEWALKS
YARDS
POOLS*



GRANALHADUS

Granalhadus



Superfície bujardada suave
Soft sandblasted surface

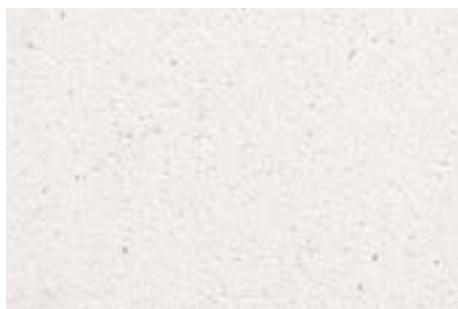

Granalhadus Branco Dunas
Granalhadus Dunas White
MDJ2020401



Granalhadus Granito Real
Granalhadus Royal Granite
MDJ2020410

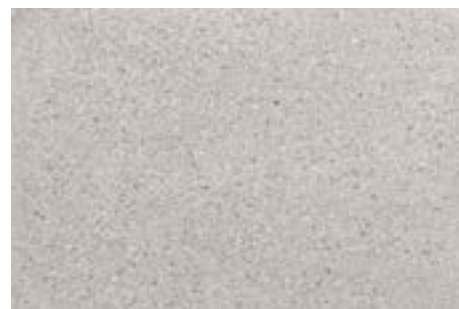

Granalhadus Granito Beirão
Granalhadus Beirão Granite
MDJ2020411



Granalhadus Negro Fráguas
Granalhadus Fráguas Black
MDJ2020402

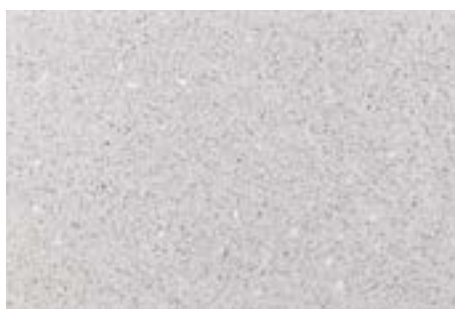

Granalhadus Pedras Salgadas
Granalhadus Pedras Salgadas
MDJ2020415



Granalhadus Creme
Granalhadus Cream
MDJ2020424

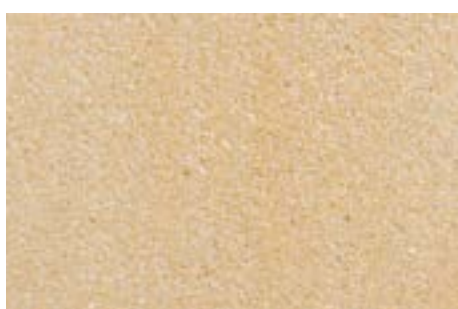

Granalhadus Amarelo Negrais
Granalhadus Negrais Yellow
MDJ2020414

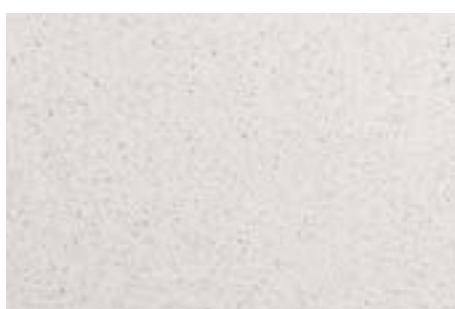

Granalhadus Lioz Branco
Granalhadus White Lioz
MDJ2020426



Granalhadus Lioz Cinza
Granalhadus Grey Lioz
MDJ2020425



Granalhadus Castanho escuro
Granalhadus Dark Brown
MDJ2020423

LONGUS

Longus



Superfície bujardada ondulada suave
Wavy smooth sandblasted surface



Longus Branco Dunas
Longus Dunas White
MDJ2030401



Longus Negro Fráguas
Longus Fráguas Black
MDJ2030402



Longus Castanho Claro
Longus Light Brown
MDJ2030422



Longus Castanho Escuro
Longus Dark Brown
MDJ2030423

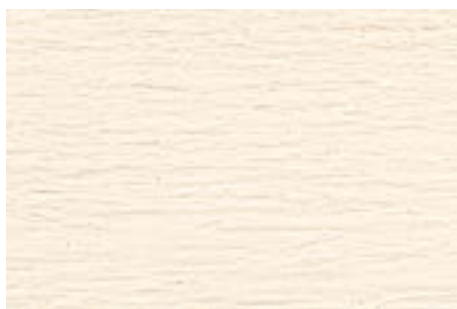

Longus Creme
Longus Cream
MDJ2030424



Longus Cinza Claro
Longus Light Grey
MDJ2030426



Longus Amarelo Ouro
Longus Gold Yellow
MDJ2030414

TOSKANA

Toskana

Superfície bujardada suave, com sulcos
Soft sandblasted surface, with grooves



Toskana Branco Dunas
Toskana Dunas White
MDJ2030501



Toskana Creme Marfim
Toskana Cream Ivory
MDJ2030513



Toskana Amarelo Ouro
Toskana Yellow Gold
MDJ2030514

ACESSÓRIOS PISCINAS

Pool Accessories



Bordadura
Border
60x40x2,5 cm



Cunha
Wedge
14/10x40x2,5 cm
Diam. 200 cm



Canto Convexo
Convex Corner
40x40x2,5 cm



Canto Côncavo (conjunto)
Concave Border (Set)
60x60x2,5 cm



Canto Côncavo Redondo (conjunto)
Rouns Concave Border (Set)
Raio / Radius 5 / 10 / 15 cm

Disponível em LONGUS, TOSKANA E GRANALHADUS.
Available in LONGUS, TOSKANA, GRANALHADUS.

TIRA

Strip

Superfície bujardada Suave
Soft sandblasted surface



Tira Longus
Longus Strip

60x19x2,5cm \approx 62Kg/m²

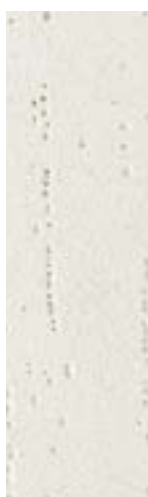

Tira Toskana
Toskana Strip

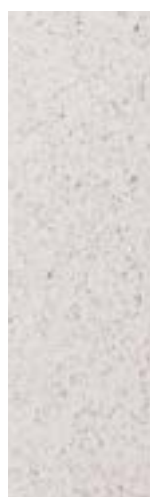

Tira Granalhadus
Granalhadus Strip



Tira Longus
Longus Strip

60x14,2x2,5 cm \approx 62Kg/m²



Tira Toskana
Toskana Strip



Tira Granalhadus
Granalhadus Strip

Disponível em todas as cores do LONGUS, TOSKANA E GRANALHADUS.
Available in all colors of LONGUS, TOSKANA AND GRANALHADUS.

Topos não serrados
Non-sawed top parts

DEGRAUS E RODAPÉS

Step Parts and Skirting-Board



Atelier d'Arquitetura Lopes do Costa | www.lopesdocosta.pt
Fotografia/Photography João Margalho

Disponível em todos os acabamentos.

Available in all finishes.

1.

Degrau

Step

58x30x2,5 cm ≈ 18,6Kg/ml

60x30x2,5 cm ≈ 18,6Kg/ml

2.

Espelho

Riser

58x15x2,5 cm ≈ 9,3Kg/ml

60x15x2,5 cm ≈ 9,3Kg/ml

3.

Rodapé

Skirting-Board

Medidas máximas / Maximum measures

38x9x2,5 cm ≈ 5,6Kg/ml

40x9x2,5 cm ≈ 5,6Kg/ml

58x9x2,5 cm ≈ 5,6Kg/ml

60x9x2,5 cm ≈ 5,6Kg/ml

Com boleado

Rounded



1.

2.

3.



Acessibilidades

Boleado, Faixa de Segurança Anti-derrapante e de Sinalização Visual Sob Consulta.

Accessibilities

Rounded, Anti-slip Signaling Safety Stripe on Request

Estilhadus, Granalhados Toskana, Longus



Distintus

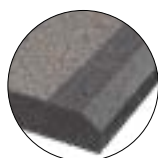

Distintus Distintus

Chanfrado sob Consulta.

Chamfered on Request

ESTEREOTOMIAS

Estereotomies

Outros desenhos e configurações

Other designs and settings

Disponível em Distintus Acetinado, Distintus Desbastado e Estilhadus.

Available in Distintus Brushed, Distintus Honed and Estilhadus.

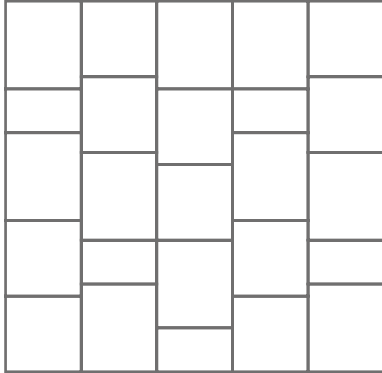

Pedra Serrada

Sawn Stone

58x50 cm; 50x50 cm; 50x29 cm

Disponível em Granalhadas, Toscana e Longus.

Available in Granalhadas, Toscana and Longus.

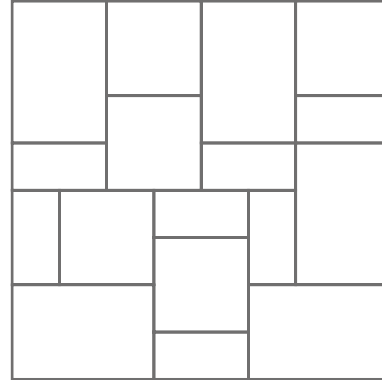

Pedra Serrada

Sawn Stone

60x40 cm; 40x40 cm; 40x20 cm

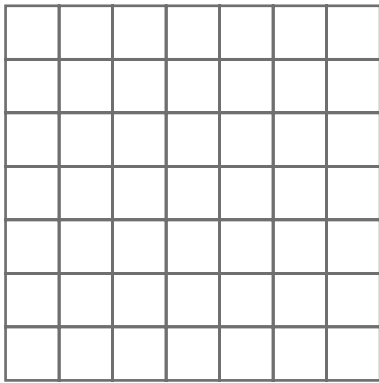

Pedra Serrada

Sawn Stone

19x19 cm

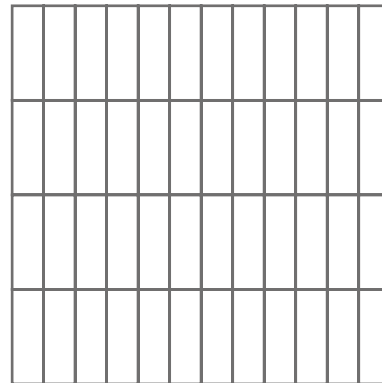

Tira Topos Não Serrados

Not Sawn Strip Stone

60x19 cm

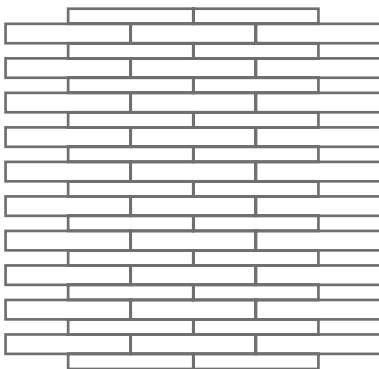

Tira Serrada

Sawn Strip

58x9 cm; 58x7 cm

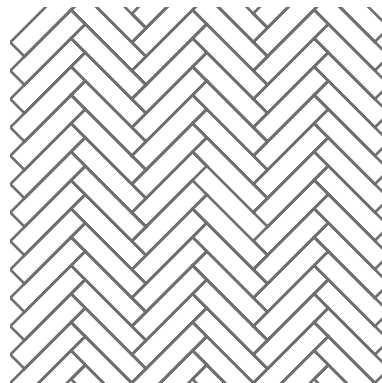

Tira Topos Não Serrados

Not Sawn Strip Stone

60x14 cm





PAVIMENTOS TÁTEIS

TACTILE PAVING SURFACE

CARACTERÍSTICAS

Mosaico Hidráulico
Pavimentos em lajetas de betão tradicionais,
com vasta gama de cores e texturas,
produtos económicos.
Absorção de água ≈ 6%.

FEATURES

*Hydraulic Mosaic
Floor coverings in concrete traditional slabs,
with a broad variety of colors and textures,
economic products. Water absorption ≈ 6%.
High Resistance.*

APLICAÇÕES

Acessibilidades, Pavimento
Exterior, Base Rígida, Uso
Pedonal.

APPLICATIONS

*Accessibilities, Outdoor Paving,
Rigid Base, Pedestrian Use*

PAVIMENTO TÁTIL

Tactile Paving

Pavimento de Perigo (Alerta)

Blister Surface



ALC011752
005 Cinza / Grey
40x40x3 cm ≈ 69 kg/m²

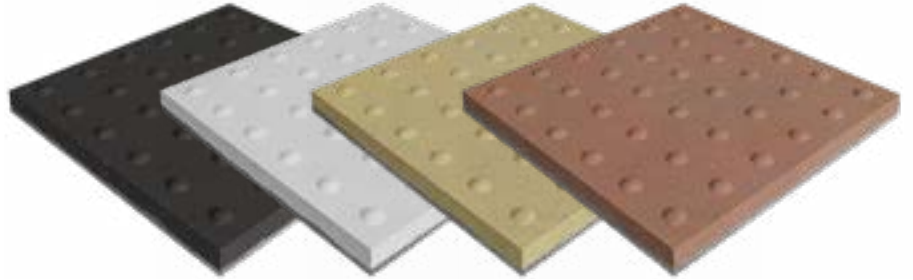

001
Preto
Black

003
Branco
White

009
Amarelo
Yellow

020
Vermelho
Red

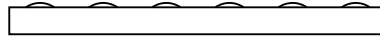
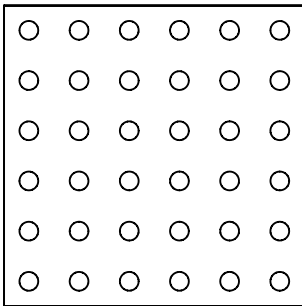

Pavimento Direcional (Guia)

Directional Guidance Surface



ALC011753
005 Cinza / Grey
40x40x3 cm ≈ 69 kg/m²

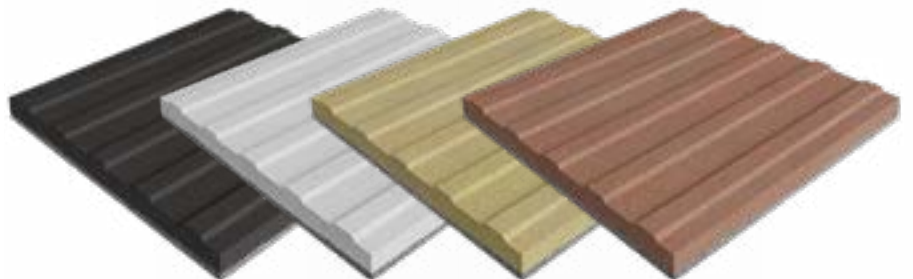

001
Preto
Black

003
Branco
White

009
Amarelo
Yellow

020
Vermelho
Red

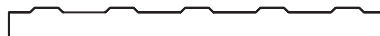
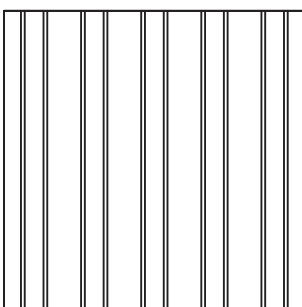

De acordo com *Accordance with NP 4564*
 Acessibilidades: Pavimentos táteis em espaço público exterior
Accessibilities: Tactile paving surfaces in outdoor public space
 Produto com incorporação de material reciclado
Product incorporating recycled material

Pavimento de Cautela

Attention Surface



ALC011751
 005 Cinza / Grey
 40x40x3 cm ≈ 69 kg/m²

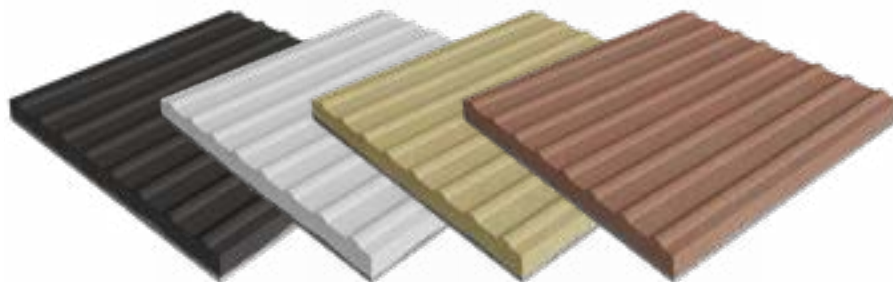

001
 Preto
 Black

003
 Branco
 White

009
 Amarelo
 Yellow

020
 Vermelho
 Red

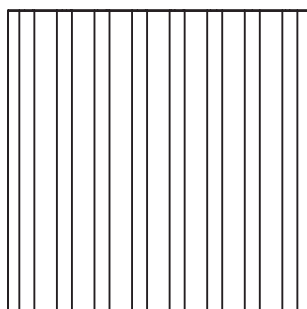

Superfície de segurança anti-derrapante superior
Superior non-slip safety surface

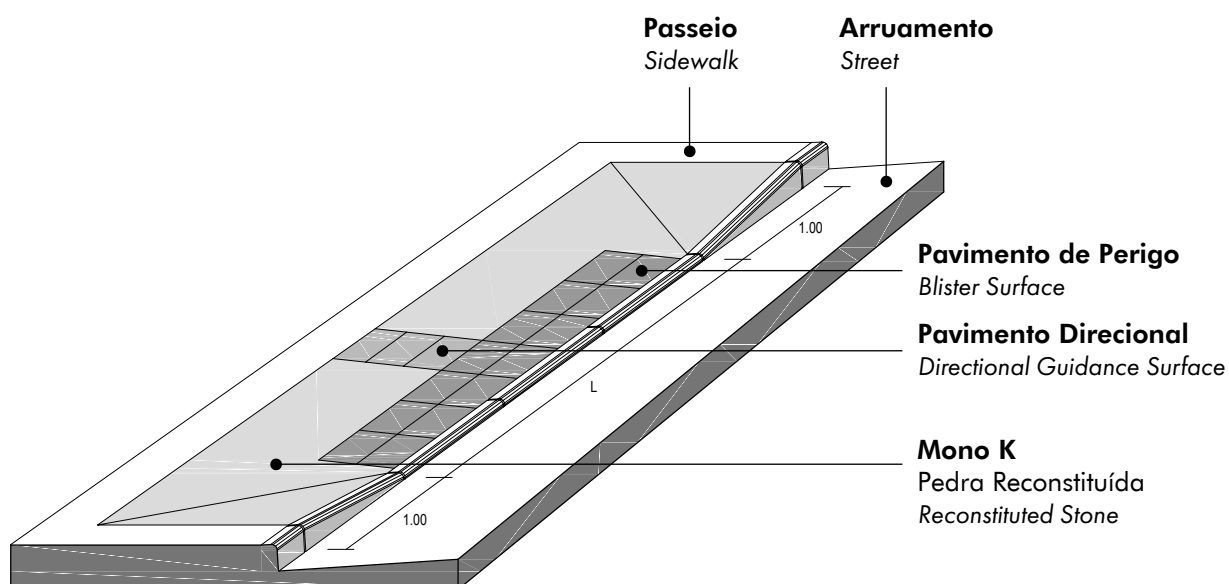

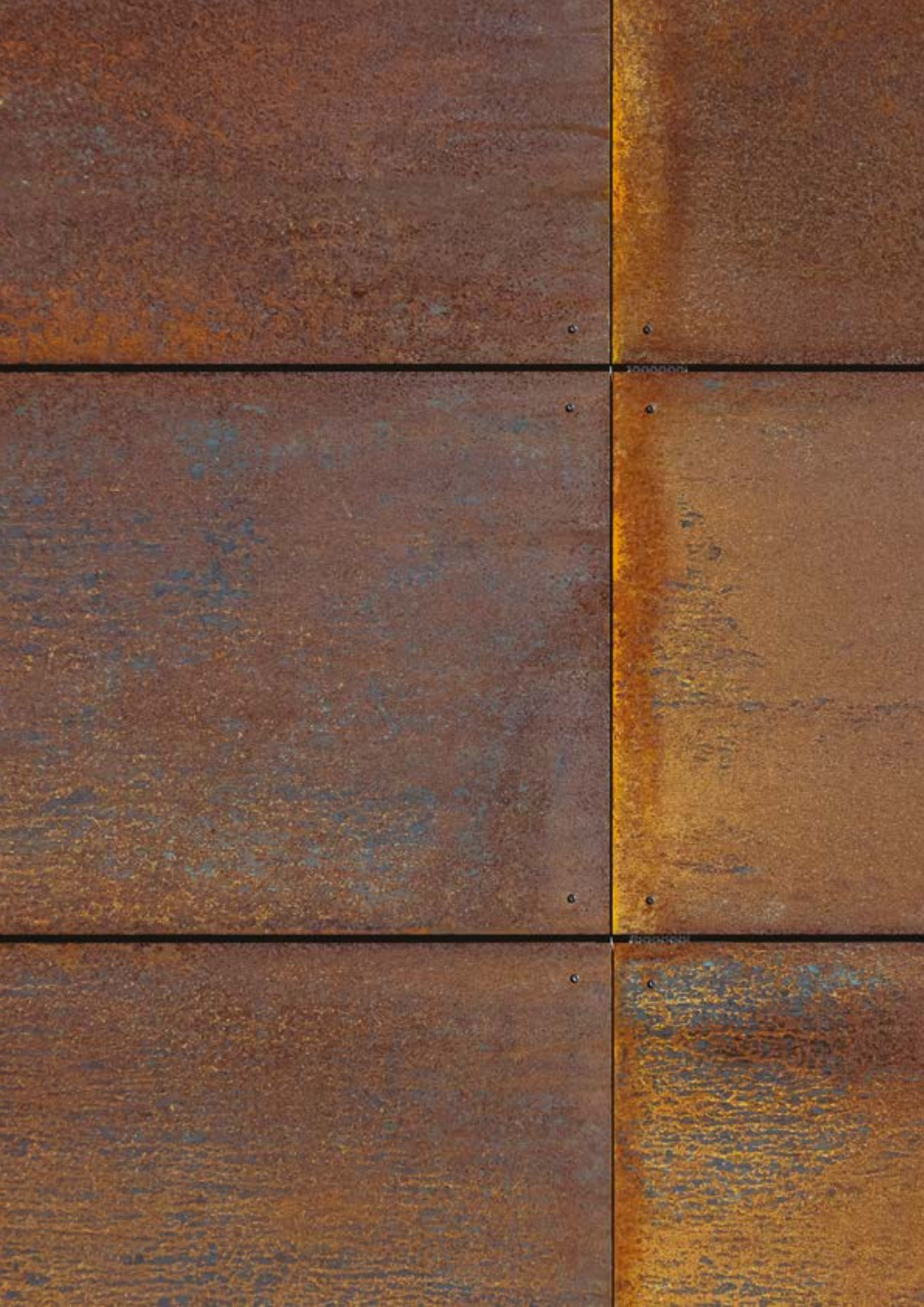

SUSTENTABILIDADE INSTALAÇÃO MATERIAIS ACABAMENTOS

*SUSTAINABILITY
INSTALATION
MATERIALS
FINISHES*

Especialistas em Betão e Aço
para Arquitetura e Design
Fabrico com elevada flexibilidade, vasta
seleção de materiais e acabamentos nobres,
com extensa gama de cores, dimensões e
texturas suaves e seguras.
Soluções sustentáveis, altamente resistentes
ao passar do tempo, ao vandalismo e aos
agentes atmosféricos, o que permite reduzir
custos de manutenção e conservação.

*Concrete and Steel Specialists
for Architecture and Design
Highly flexible manufacture, a wide selection of
materials and noble finishes, with an extensive
range of colours, sizes and smooth and safe
textures.
Sustainable solutions, extremely resistant to
aging, vandalism and atmospheric agents, which
reduce maintenance and conservation costs.*

SUSTENTABILIDADE

A Sustentabilidade na Amop

Na Amop, trabalhamos a pensar no futuro e por isso promovemos a produção sustentável e a proteção ambiental.

Otimização de Recursos

Procuramos fazer uma gestão eficiente de todos os recursos usados na Amop.

Energia Renovável

Foram instalados mais de 1.000 painéis fotovoltaicos, nas nossas instalações, privilegiando assim o aumento do consumo de energias renováveis.

Aprovisionamento Local

Todas as nossas matérias-primas e materiais complementares, têm origem em fornecedores locais.

Eco-Materiais

Desenvolvemos novos eco-materiais, sob a forma de novas formulações de betão, com incorporação de materiais e resíduos reciclados certificados.

Como materiais complementares, selecionamos madeiras, aços e plásticos reciclados, sustentáveis, com baixa manutenção. Privilegiamos na produção a texturização com meios mecânicos, não tóxicos.

Produtos 100% Recicláveis

Os produtos em betão são unicamente compostos por cimento, areia, agregados e água, sendo 100% recicláveis.

Gestão de Resíduos

A água rejeitada, no processo de produção, é tratada, filtrada e reutilizada internamente.

Os restos de argamassas, lamas secas e cortes, são submetidos a processo de recolha e reutilização, valorizando-os e reincorporando com a matéria prima. 99,9% dos resíduos são coletados e enviados para reciclagem por entidades credenciadas.

Responsabilidade Social

A Amop criou projetos sociais, entregando produtos não comercializados, como mobiliário urbano recuperado, produtos de exposição e protótipos a instituições ou entidades relevantes na comunidade.

Todos os dias procuramos um bom desempenho empresarial da forma mais sustentável possível. Combinando o fabrico de produtos simples mas que resultem em soluções inovadoras, otimizando os recursos e o ciclo de vida dos produtos.

O betão é um material sustentável composto por uma seleção de minerais, totalmente compatível com uma reciclagem eficiente.

As vantagens do design Amop, como a durabilidade, a resistência climatérica, a pouca manutenção e a baixa pressão ambiental, são critérios decisivos numa escolha consciente para a sustentabilidade.

Responsabilidade

Os fatores distintivos dos produtos e do design Amop, como a durabilidade, a resistência climatérica, a pouca manutenção necessária, e baixa pressão ambiental, são critérios decisivos numa escolha consciente, promovendo a sustentabilidade.

Pretendemos dar um bom uso aos materiais e produtos excedentes na produção, por isso criamos projetos sociais, num incentivo ao desenvolvimento sustentável e à fabricação com desperdício zero.

Equipamentos urbanos recuperados - mobiliários de exposição e protótipos renovados que oferecemos a instituições sociais relevantes na comunidade.

Presentes originais com design – peças fabricadas com os materiais excedentes da produção, com design de autor e produzidas manualmente.

Produto

Fabricamos utilizando materiais e processos de fabrico, com menor intensidade de recursos no fabrico e na manutenção.

Consideramos todas as etapas do ciclo de vida na fase de projeto, desde a obtenção de matérias-primas até a gestão de resíduos, incluindo a sua fabricação, distribuição, instalação, manutenção e desinstalação.

Durabilidade e resistência

Os pavimentos, os revestimento e o mobiliário urbano cumprem dois requisitos essenciais:

Produtos duradouros e resistentes às condições adversas (intempéries e vandalismo) com necessidade de uma manutenção mínima (limpeza e componentes).

Procuramos um desempenho melhor e de forma mais sustentável, combinando o fabrico dos produtos simples, com soluções inovadoras, otimizando os recursos e o ciclo de vida, garantindo que cada produto seja único, especial e sustentável.

SUSTAINABILITY

Sustainability at Amop

At Amop, we work with the future in mind and that is why we promote sustainable production and environmental protection.

Resource Optimization

We seek to efficiently manage all the resources used at Amop.

Renewable energy

More than 1,000 photovoltaic panels were installed in our facilities, thus favoring increased consumption of renewable energy.

Local Procurement

All of our raw materials and complementary materials are sourced from local suppliers.

Eco-Materials

We develop new eco-materials, in the form of new concrete formulations, incorporating certified recycled materials and waste. As complementary materials, we select wood, steel and recycled plastics, sustainable, with low maintenance. In production, we privilege texturing with mechanical, non-toxic means.

100% Recyclable Products

Concrete products are only composed of cement, sand, aggregates and water, being 100% recyclable.

Waste Management

The rejected water, in the production process, is treated, filtered and reused internally.

The remains of mortar, dry sludge and cuts are subjected to a process of collection and reuse, valuing them and reincorporating them with the raw material. 99.9% of waste is collected and sent for recycling by accredited entities.

Social responsibility

Amop created social projects, delivering unmarketed products, such as reclaimed urban furniture, exhibition

products and prototypes to relevant institutions or entities in the community. Every day we seek good business performance in the most sustainable way possible. Combining the manufacture of simple products that result in innovative solutions, optimizing the resources and the life cycle of the products.

Concrete is a sustainable material composed of a selection of minerals, fully compatible with efficient recycling.

The advantages of the Amop design, such as durability, weather resistance, low maintenance and low environmental pressure, are decisive criteria in a conscious choice for sustainability.

Responsability

The distinguishing factors of Amop products and design, such as durability, weather resistance, the little maintenance required, and low environmental pressure, are decisive criteria in a conscious choice, promoting sustainability.

We intend to make good use of surplus materials and products in production, which is why we created social projects, encouraging sustainable development and manufacturing with zero waste.

Refurbished urban equipment - exhibition furniture and renovated prototypes that we offer to relevant social institutions in the community.

Original gifts with design - pieces manufactured from surplus production materials, with author's design and handmade produced.

Product

We manufacture by using materials and manufacturing processes, with less intensity resources in production and maintenance.

We consider all stages of the life cycle in the design phase, from obtaining raw materials to managing waste, including its manufacture, distribution, installation, maintenance and uninstallation.

Durability and resistance

Pavements, cladding and urban furniture fulfill two essential requirements:

Long-lasting products that are resistant to adverse conditions (weather and vandalism) with the need for minimal maintenance (cleaning and components).

We look for better performance and in a more sustainable way, combining the manufacture of simple products, with innovative solutions, optimizing resources and the life cycle, ensuring that each product is unique, special and sustainable.

TIPO DE INSTALAÇÃO REVESTIMENTO

COVERINGS INSTALLATION TYPE

MONO K

Consultar sistemas adequados <i>Consult adequate systems</i>	Standard <i>Standard</i>		ECO TECH <i>Espessura Thickness ≥ 3,5 cm</i>	
	38x58x2,5 cm 40x60x2,5 cm	58x58x2,5 cm 60x60x2,5 cm	78x28x3,5 cm 78x58x3,5 cm	60x60x3,5 cm 80x60x3,5 cm
Absorção de água (% Vol) <i>Water Absorption (% Vol)</i>	2,7			
Peso m ² (Aproximado kg/m ²) <i>Weight m² (Approximate kg/m²)</i>	62		87	92
SOLUÇÕES APLICAÇÃO APPLICATION SOLUTIONS				
Fachada Ventilada (grampeamento / perfilaria) <i>Ventilated Facade (stapling / profiling)</i>	Ancoragem em Ranhura <i>Anchoring in Groove</i>		Ancoragem em Furo <i>Anchoring in Hole</i>	
	Adequado (em função da fixação mecânica de suspensão) <i>Adequate (depending on the mechanical suspension fixation)</i>			
Fachada Mista (colagem / fixação mecânica) <i>Mixed Facade (gluing / mechanical fixing)</i>	Colagem e Fixação Mecânica (de Segurança) <i>Gluing and Mechanical Fixation (for security)</i>			
	Adequado (em função das dimensões) <i>Adequate (depending on the dimensions)</i>			
Aplicação em Base Rígida (betonilha / laje) <i>Rigid Base Application (screed / slab)</i>	Pedonal e Rodoviário (Tráfego Ligeiro <3500 kg) <i>Pedestrian and Road (Light Traffic <3500 kg)</i>		Pedonal e Rodoviário (Tráfego Pesado >3500 kg) <i>Pedestrian and Road (Heavy Traffic >3500 kg)</i>	
	Adequado (em função dos valores de resistência ao abrasão) <i>Adequate (depending on abrasion resistance wear values)</i>			
Aplicação em Base Semi-Rígida (traço de areia e cimento) <i>Semi-Rigid Base Application (stroke of sand and cement)</i>	Pedonal <i>Pedestrian</i>			
	Uso Normal <i>Normal Use</i>		Uso Intensivo <i>Intensive Use</i>	
Aplicação em Base Flexível (areia / pó de pedra) <i>Flexible Base Application (sand / stone powder)</i>	Pedonal <i>Pedestrian</i>			
	Uso Normal a Intensivo <i>Normal to Intensive Use</i>			
Aplicação como Passo (relva / gravilha) <i>Stepping Application (grass / gravel)</i>	Pedonal <i>Pedestrian</i>			
	Uso Normal <i>Normal Use</i>		Uso Intensivo <i>Intensive Use</i>	
Aplicação Sobre Apoios (gama recomendada) <i>Application On Supports (recommended range)</i>	Pedonal <i>Pedestrian</i>			
	Uso Normal <i>Normal Use</i>			
	Apoios Pontuais / Contínuos <i>Occasional / Continuous Supports</i>			
SOLUÇÕES TRATAMENTO TREATMENT SOLUTIONS				
Limpeza e Proteção (gama recomendada) <i>Cleaning and Protection (recommendes range)</i>	Limpeza - Cleancrete AC <i>Cleaning - Cleancrete AC</i>			
	Proteção - Treatstone ISP <i>Protection - Treatstone ISP</i>			

TIPO DE INSTALAÇÃO MOBILIÁRIO

FURNITURE INSTALLATION TYPE

URBAN PRIVATE



Simplemente Apoiado

Self-Standing

Produto instalado sobre a superfície, autoportante, sem necessidade de fixação.

Product installed on the surface level, self-standing, with no need for any type of fixation system.

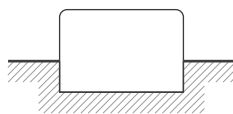

Encastrado Simples

Recessed Setting

Produto instalado abaixo do nível da superfície, sem necessidade de fixação.

Product installed below surface level, with no need for any type of fixation system.

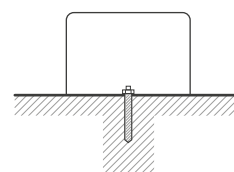

Fixação de Superfície

Surface permanent anchoring

Produto instalado sobre a superfície, com fixação oculta por sistema de perno roscado e resina epoxy.

Product installed on the surface level, with hidden threaded rod and epoxy resin anchoring system.

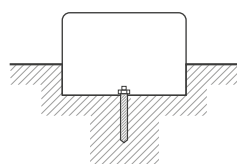

Encastrado com Fixação

Anchored Recessed Setting

Produto instalado abaixo do nível da superfície, com fixação por sistema de perno roscado e resina epoxy.

Product installed below surface level, with threaded rod and epoxy resin anchoring system.

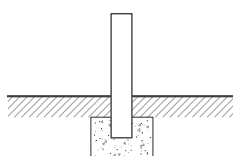

Encastrado Rígido

Concrete Base Setting

Produto instalado abaixo do nível da superfície, com fixação em sapata de betão executada *in situ*.

Product installed below surface level, on concrete base carried out *in situ*.

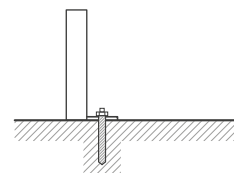

Aparafusamento de Superfície

Surface Bolted Anchoring

Produto instalado ao nível da superfície, com fixação aparente por ancoragem mecânica.

Product installed above surface level, on rigid base, with apparent mechanical anchoring system.

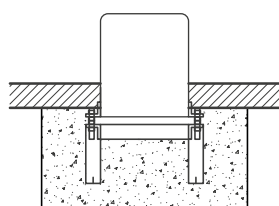

Chumbadouro de Superfície

Surface Platform Anchoring

Produto instalado sobre chumbadouro previamente fixado em sapata de betão, executada *in situ*.

Product installed via anchoring system previously attached to concrete base, carried out *in situ*.

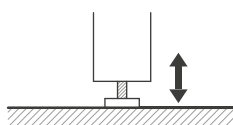

Sistema de Apoio Regulável

Adjustable Support System

Sistema de apoio regulável em altura com amplitude máxima aproximadamente de 1 cm.

Height-adjustable support system with a maximum amplitude of approximately 1 cm.

URBAN

MAPA DE MATERIAIS E ACABAMENTOS MATERIALS AND FINISHES MAP

Aço Natural

Natural Steel



Aço Inox
Stainless Steel



Aço Galvanizado
Galvanized Steel



Aço Corten
Corten Steel

Aço Metalizado Pintado (Standard)

Painted Metallized Steel (Standard)



Antracite Micro Texturado

Micro Textured Anthracite

RAL 7016

Outras cores recomendadas sob consulta

Other recommended colors on request

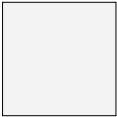

Branco
White
RAL 9010



Cinza
Grey
RAL 7001



Preto Liso
Smooth Black
9017



Amarelo
Yellow
RAL 1012



Azul
Blue
RAL 5024



Vermelho
Red
RAL 3022



Verde
Green
RAL 6021

Madeira

Wood



Contraplacado Marítimo
Maritime Plywood
Bétula
Birch



Tropical Iroko
Tropical Iroko



Termotratada Pinho
Thermo-treated Pine



Plástico Reciclado

Recycled Plastic

PRIVATE

MAPA DE MATERIAIS E ACABAMENTOS MATERIALS AND FINISHES MAP

Aço Metalizado Pintado (Standard)

Painted Metallized Steel (Standard)



Antracite Micro Texturado

Micro Textured Anthracite

RAL 7016

Outras cores recomendadas sob consulta

Other recommended colors on request



Branco Liso Micro Texturado

*Micro Smooth
White Texture*

RAL 9010



Preto Micro Texturado

*Micro Black
Texture*

RAL 9017



Corten Micro Texturado

*Micro Textured
Corten*

Madeira

Wood



Contraplacado Marítimo

*Maritime
Plywood*

Bétula
Birch



Tropical Iroko

*Tropical
Iroko*



Termotratada Pinho

*Thermo-treated
Pine*

Plástico Reciclado

Recycled Plastic



MAPA GLOBAL DE MATERIAIS

GLOBAL MATERIALS MAP

Materiais Materials		Tratamento Superfície Surface Treatment		Acabamento Finishes	
Betão CS/ES	<i>CS/ES Concrete</i>	Hidrofugado	<i>Waterproof</i>	Liso	<i>Smooth</i>
		Antigrafitti	<i>Anti Grafitti</i>	Desbastado	<i>Honed</i>
		Verniz Incolor	<i>Colorless Varnish</i>	Bujardados	<i>Shot Blasted</i>
		Pintura Base Poliuretano	<i>Painting Polyurethane Base</i>	Liso	<i>Smooth</i>
Betão UHPC	<i>UHPC Concrete</i>	Hidrofugado	<i>Waterproof</i>	Liso	<i>Smooth</i>
		Antigrafitti	<i>Anti Grafitti</i>	Bujardado Suave	<i>Sandblasted</i>
		Verniz Incolor	<i>Colorless Varnish</i>	Liso	<i>Smooth</i>
		Pintura Base Poliuretano	<i>Painting Polyurethane Base</i>	Bujardado Suave	<i>Sandblasted</i>
Aço	<i>Steel</i>	Metalizado	<i>Metallized</i>	Pintado	<i>Painted</i>
		Galvanizado	<i>Galvanized</i>	Pintado	<i>Painted</i>
Aço Inox	<i>Stainless Steel</i>			Natural	<i>Natural</i>
Aço Corten	<i>Corten Steel</i>	Pré-oxidado	<i>Pre-oxidized</i>	Escovado	<i>Brushed</i>
		Bujardado Suave	<i>Sandblasted</i>	Envernizado	<i>Varnish</i>
		Em Bruto	<i>Rough</i>	Natural	<i>Natural</i>
Madeira Tropical Iroko	<i>Iroko Tropical Wood</i>	Natural	<i>Outdoor Stain</i>		
Madeira Termo-tratada Pinho	<i>Thermo-treated Wood Pine</i>	Natural	<i>Natural</i>		
		Velatura p/ Exterior	<i>Outdoor Stain</i>		
Contraplacado Marítimo	<i>Plywood Maritime</i>	Natural	<i>Natural</i>		
		Velatura p/ Exterior	<i>Outdoor Stain</i>		

MATERIAIS

MATERIALS

Madeira

A madeira é um material orgânico, de natureza resinosa (pinho termotratado) ou não resinosas (madeira tropical) com funções de sustentação mecânica e/ou acabamento decorativo.

É um material natural, resistente e leve, utilizado pelo seu valor estético e de conforto. Poderá ser natural, contraplacado e com tratamento adequado para exteriores.

Tipos Seleccionados:

Madeira Termotratada
Pinho

Madeira Tropical
Iroko

Contraplacado Marítimo

Utilizamos madeiras seleccionadas, para melhor durabilidade e envelhecimento, trabalhamos com acabamento de madeira natural, ou madeira com velatura.

A madeira adequada seleccionada, apresenta além do seu acabamento natural inicial, uma evolução para um aspeto oxidado natural com o tempo.

As diferenças principais entre vernizes e velaturas relacionam-se com a durabilidade (superior no verniz) e com a facilidade de aplicação e manutenção (superior na velatura).

Embora os vernizes tenham uma maior durabilidade e resistência, geralmente alteram e escurecem a madeira, enquanto que as velaturas conferem à madeira um aspecto mais natural e são mais fáceis de aplicar e manter.

Wood

Wood is an organic material, of resinous (heat-treated pine) or non-resinous (tropical wood) nature, with mechanical support and / or decorative finish functions.

It is a natural, resistant and light material used for its aesthetic and comfort value. It may be natural, plywood and with appropriate treatment for outdoor use.

Selected Types:

Thermo-treated wood
Pine

Tropical Madeira
Iroko

Maritime Plywood

We use selected woods, for better durability and aging, working with natural wood finish, or wood with stain.

The selected suitable wood, in addition to its initial natural finish, has evolved to a natural oxidized appearance over time.

The main differences between varnishes and stains are related to durability (superior in varnish) and easy of application and maintenance (superior in stain).

Although varnishes have greater durability and resistance, they generally alter and darken the wood, while the stains give the wood a more natural appearance and both application and maintenance are easier.

Recycled Plastic

Solução sustentável e duradoura. 100% Reciclado. Pode ser serrado, maquinado, pregado e pintado. Resistente à corrosão não apodrece e é inalterável. Baixo custo de ciclo de vida, sem manutenção e fácil de lavar.

Recycled Plastic

Sustainable and lasting solution. 100% recycled. It can be sawn, machined, nailed and painted. Corrosion-resistant, doesn't deteriorate and remains unchanged. Low life-cycle cost, maintenance free and easy to wash.



Madeira Tropical
Tropical Wood



Madeira Termotratada
Thermo-treated



Contraplacado Marítimo
Maritim
Plywood



Plástico Reciclado
Recycled Plastic

MATERIAIS

MATERIALS

Aço

O aço é uma liga do sistema ferro-carbono trabalhável, suscetível de adquirir formas muito diversas por meio de maquinação adequada.

Tratamento anti-corrosão por galvanização ou metalização e acabamento pintado.

Steel

Steel is an alloy of the workable ferrocarbon system, which is capable of taking on very different shapes through proper machining.

Anti-corrosion treatment by galvanization or metallization and painted finish.

Aço Inoxidável

Garante elevada resistência à corrosão, protegendo o material de ataques corrosivos em contacto com a humidade. Como padrão, é usado o AISI 304. No entanto, em meios salinos ou ácidos, classificados como C5, é recomendado o AISI 316 ou superior.

A superfície é tratada por escovagem ou polimento, gerando acabamentos e aparências distintas, com uma alta durabilidade e manutenção mínima.

Stainless Steel

It guarantees high resistance to corrosion and protects the material from corrosive attacks when in contact with humidity. As standard, AISI 304 is used. However, in C5-classified maritime or acid environments, AISI 316 or higher is recommended.

The surface is subject to a brushing or polishing treatment, which generates highly durable and low maintenance different finishes and appearances.

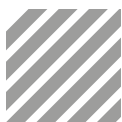

Aço Inox
Stainless Steel

Aço Corten

Aço patinável, também conhecido como Corten, é um tipo de aço que, na sua composição, contém elementos que melhoram as suas propriedades anticorrosivas. O óxido de ferro e cobre decorrente da oxidação, forma uma camada “envelhecida”, denominada de Patine, que impede a progressão da oxidação.

Além de dispensar a pintura, oferece maior resistência em ambientes de exposição severa, com um acabamento de baixa manutenção, longa durabilidade e elevado ciclo de vida.

Corten Steel

Patinable steel, also known as Corten, is a type of steel that, in its composition, contains elements that improve its anti-corrosion properties. The iron and copper oxide resulting from oxidation, forms an “aged” layer, called Patine, which prevents the progression of oxidation.

In addition that painting is dispensed, it also offers greater resistance in severe exposure environments, with a low maintenance finish, long durability and long life cycle.



Aço Corten
Corten Steel

Pintura

Tinta Electroestática a Pó - Revestimento uniforme com bom acabamento. Boas características de aderência ao suporte, resistência à abrasão e resistência química. Não contém solventes e não emite compostos orgânicos voláteis (COV) para a atmosfera.

Painting

Electrostatic Powder Paint – An even coating with a good finish. Good structure adhesion characteristics, abrasive-resistant and chemical resistance.

Does not contain solvents, not emitting volatile organic compounds (VOCs) into the atmosphere.

Metalização

Protecção de superfície projectando zinco ou zinco/alumínio, com desoxidação e desengorduramento com jacto abrasivo por granalha, atingindo o depósito de zinco uma espessura mínima de 30-40 microns.

Metallization

Surface protection projecting zinc or zinc / aluminium, with deoxidation and degreasing with abrasive jet by grit, attaining the minimum thickness of zinc deposit of 30-40 microns.



Aço Metalizado
Metallized Steel

Galvanização

Protecção de superfície por imersão num banho de zinco (mín. 98% Zinco) a cerca de 450°C. Ao reagir com a superfície metálica, forma uma liga de Zinco/Ferro. A espessura mínima de zinco é de 60 microns.

Plating

Surface protection by immersion in a zinc bath (98% min. Zinc) at about 450°C. When reacting with the metallic surface, it forms a Zinc / Iron alloy. The minimum zinc thickness is 60 microns.



Aço Galvanizado
Galvanized Steel

AÇO CORTEN

CORTEN STEEL

Caracterização

O aço corten é considerado um material "vivo", pelo processo evolutivo de maturação / oxidação que o caracteriza, podendo variar ao longo do tempo em tonalidades e matizes, dependendo da sua forma, posição em que está instalado o objeto e exposição e ciclos de desgaste.

A rapidez de oxidação e tonalidade podem variar dependendo do tipo de exposição ambiental a que o elemento esteja sujeito. O período médio de estabilização do ciclo natural de maturação do corten é de cerca de 12/18 meses, na presença de condições meteorológicas adequadas.

Soluções AMOP

- Aço Corten Pré-oxidado, com acabamento envernizado, tratamento especial para reduzir os escorrimentos do processo de oxidação "ANTI-WASH-OUT" (quando solicitado pelo cliente, por um custo adicional). Este tratamento não bloqueia completamente as perdas mas diminui significativamente o vazamento de óxido, dando ao produto um aspecto e acabamento mais escuros.
- Aço Corten Pré-oxidado, com acabamento natural, usando um processo de aceleração de oxidação executado em fábrica.
- Aço Corten Decapado, para uma oxidação natural mais rápida em obra.
- Aço Corten Bruto, sujeito a uma oxidação natural mais lenta em obra.

Importante

- No caso de instalação sobre superfícies valiosas/porosas, atendendo a eventuais escorrimentos naturais, poderá ser aconselhável utilizar aço metalizado ou galvanizado com "cor corten".

— Corten Natural *Natural Corten* —



Aparência / Tonalidades no momento inicial de oxidação.

Appearance / Shades in the initial moment of oxidation.



Aparência / Tonalidades no final do período de oxidação.

Appearance / Shades in the end of the oxidation period.

Corten Envernizado *Varnish Corten*



Tratamento especial e proteção Amop "Anti-Washout".

Special treatment and Amop's "Anti-Washout" protection.

Characterization

Corten steel is considered a "living" material, due to the maturation / oxidation evolutionary process that characterizes it, which may vary over time in tones and hues, depending on its shape, position in which the object is installed and exposure / wear cycles. The speed of oxidation and tones may vary depending on the type of environmental exposure to which the element is subjected to. Corten's average period of stabilization of the natural maturation cycle is about 12/18 months, under adequate meteorological conditions.

AMOP Solutions

- Pre-oxidized Corten steel, with varnished finish, special treatment to reduce drip off from the oxidation process, "ANTI-WASHOUT" (on request by the customer, with an additional cost). This treatment does not completely block losses, but it considerably reduces oxide leakage, giving the product a darker appearance and finish.
- Pre-oxidized Corten Steel, with a natural finish, using a factory-run oxidation acceleration process.
- Pickled Corten Steel, for a faster natural oxidation on site.
- Rough Corten Steel, subject to a slower, natural oxidation on site.

Important

- In case of installation on valuable/porous surfaces, taking into account any natural washout, it may be advisable to use metallic or galvanized steel with "corten color".

BETÃO UHPC

ULTRA HIGH PERFORMANCE CONCRETE

LISO PINTADO

SMOOTH PAINTED

Sobre a superfície lisa do betão é aplicada uma pintura com tinta de base poliuretano" disponível em várias cores standard ou sob consulta na paleta de cores.

The paint with a polyurethane base is applied on the smooth concrete surface. Several standard colours are available or on request, according to Amop colour pallet chart.



UHPC IP B299
VERMELHO
RED



UHPC IP E230
LARANJA
ORANGE



UHPC IP Z319
AMARELO
YELLOW



UHPC IP F445
VERDE
GREEN

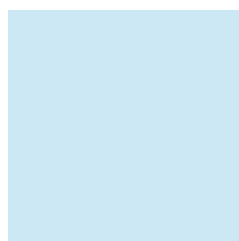

UHPC IP S419
AZUL
BLUE



UHPC IP M231
CASTANHO
BROWN

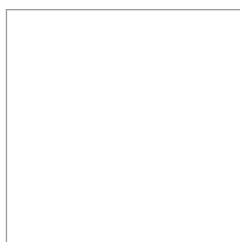

UHPC IP B000
BRANCO
WHITE

LISO PIGMENTADO

SMOOTH PIGMENTED

A superfície que sai do molde é deixada intacta, mostrando apenas a goma do betão.

The surface coming out of the mould is left untouched, showing only the concrete skin.

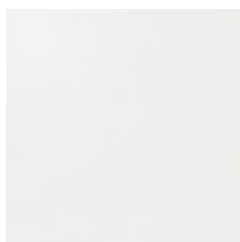

UHPC 400 BR
BRANCO
WHITE



UHPC 400 CZ
CINZA
GREY

BUJARDADO SUAVE

SANDBLASTED

Superfície de aspeto liso rugoso mate. Acabamento que se assemelha ao aspeto da pedra natural jateada homogénea.

Smooth matt rough-looking surface. Finish that resembles the look of homogeneous sandblasted natural stone.

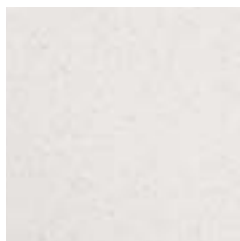

UHPC 470 BR
BRANCO
WHITE



UHPC 470 CZ
CINZA
GREY

BETÃO UHPC

ULTRA HIGH PERFORMANCE CONCRETE

Formulação UHPC (Ultra High Performance Concrete), design, processo de conformação - um projeto inovador concebido num processo de co-investigação entre a indústria e o design.

VANTAGENS CHAVE

- Redução de Peso para aproximadamente metade, resultante do redesign minimalista;
- Redução de Espessura (até 3x menos);
- Elevada resistência à compressão (cerca de 2x maior);
- Absorção de água correspondente a metade dos betões convencionais;
- Grau de compactação do betão 2x maior, face à redução de teor de vazios;
- Maior durabilidade do elemento em betão devido à elevada dosagem de cimento;
- Elevada resistência ao envelhecimento e inexistência de perda de massa em ciclos de gelo/degelo;
- Resistência à Abrasão (1.6x superior ao betão convencional);
- Capacidade de reprodução de texturas com traço fino e realização de geometrias únicas.

ACABAMENTOS

- Betão: Liso pintado / Liso pigmentado / Bujardado Suave
- Verificar Mapa de Cores e Carta de Acabamentos

TRATAMENTOS

- Hidrofugado
- Anti-graffiti
- Verniz de poliuretano

An UHPC formula (Ultra High Performance Concrete), design, moulding process – an innovative project conceived under a co-investigation process between industry and design.

KEY ADVANTAGES

- Weight reduction to nearly half, as a result of the minimalistic design;
- Thickness reduction (up to 3 times less);
- High Resistance to Compression (approx. 2 times higher);
- Water absorption corresponding to half of conventional concretes;
- Concrete compact degree 2 times higher, due to reduction of voids;
- Greater Durability of concrete element due to high cement dosage;
- High resistance to aging and inexistence of mass loss during frost and defrost cycles;
- Resistance to Abrasion (1.6 times higher than conventional concrete);
- Ability to reproduce fine textures and unique geometries.

FINISHING

- Concrete: Smooth painted / Smooth pigmented / Sandblasted
- Check Colors and Finishing Charts

TREATMENTS

- Waterproof
- Anti-graffiti
- Polyurethane varnish



aresta viva
sharp edge



aresta biselada
beveled edge



aresta boleada
rounded edge

Alguns acabamentos poderão determinar o tipo de aresta.
Some finishes may determine the type of edge.

Qualquer produto poderá ter sistema de fixação ao solo.
Any product may have a ground fixation system.

BETÃO RECICLADO

RECYCLED CONCRETE



Estes produtos ecológicos integram resíduos industriais reciclados no betão, promovendo a sustentabilidade e a protecção do meio ambiente através da economia circular. Para modelos de betão natural produzido com acabamento moldado. Tratam-se de produtos ambientalmente sustentáveis com os padrões de qualidade Amop.

These ecological products integrate recycled industrial waste into concrete, promoting sustainability and protection of the environment through circular economy. Destined to models of natural concrete produced with moulded finish. These are environmentally sustainable products with Amop quality standards.



RE-CYCLE



RE-CYCLE LISO CINZA NATURAL

A superfície obtida do molde é deixada com o aspeto natural, apresentando pequenas imperfeições, porosidades e manchas.

RE-CYCLE NATURAL SMOOTH GREY

The surface resulting from unmoldings, is left with its natural appearance showing small imperfections, porosities and stains.



RE-CYCLE BUJARDADO CINZA NATURAL

A superfície é sujeita a processo de bujardamento, apresentando o aspeto irregular dos agregados reciclados e do betão à vista.

RE-CYCLE NATURAL SANDBLASTED GREY

The surface is subject to a bush hammering process showing the irregular appearance of the recycled aggregates and the exposed concrete.

BETÃO RECICLADO

RECYCLED CONCRETE

RE-CYCLE

Desenvolvemos novos eco-materiais sob a forma de novas formulações com material reciclado, com base em agregados de resíduos de demolição e construção (RCD) e outros resíduos industriais. As novas formulações dão origem a produtos que são mais sustentáveis e com menor impacto no meio ambiente.

ACABAMENTO

Um sofisticado material bruto, em betão cinza, com pequenas manchas, porosidades e imperfeições naturais ou microfissuras, que são características próprias deste material e respetiva incorporação de RCD.

Poderá adquirir outra pigmentação sob orçamento.

VANTAGENS CHAVE

- Uso de agregados reciclados
- Menor consumo de água
- Redução do consumo de energia
- Custos de manutenção mais baixos
- Elevada longevidade
- Otimização económica

PRODUÇÃO

Enquadra-se como um processo de produção mais curto, com menor consumo de água, utilizando **aproximadamente de 25% até 40% dos agregados de demolição e construção reciclada** (resíduo obtido de produtos e estruturas de betão). Poderão ser fabricados outros elementos com menor ou maior percentual de reciclado. Após um processo de reciclagem, os agregados (RCD) são reconvertidos em matéria-prima da melhor qualidade para incorporação em elementos de betão Amop, com a marcação CE e produto reciclado e certificado TÜV.

We have developed new eco-materials using new formulations with recycled material, based on aggregates from demolition and construction waste (DCW) and other industrial waste. The new formulations give rise to more sustainable products and cause less impact on the environment.

FINISHING

A sophisticated rough material, in grey concrete, with small stains, porosities and natural imperfections or microcracks, are inherent characteristics of this material and its respective CDW incorporation. Other pigmentations available on request through quotation.

KEY ADVANTAGES

- Use of recycled aggregates
- Lower water consumption
- Reduced energy use
- Lower maintenance costs
- High longevity
- Economic optimization

PRODUCTION

It is a shorter production process, with less water consumption, using **from 25 up to 40% approximately of recycled demolition and construction aggregates** (waste obtained from concrete products and structures). Other elements with a lower or higher percentage of recycled content can be manufactured. After a recycling process, the aggregates (DCW) are converted into the best quality raw material to incorporate in Amop concrete elements, with CE marking and TUV certified recycled product.

BETÃO CS / ES

CAST STONE / ENGINEERED STONE CONCRETE

LISO PINTADO

SMOOTH PAINTED

Sobre a superfície lisa do betão é aplicada uma pintura com tinta de base poliuretano" disponível em várias cores standard ou sob consulta na paleta de cores.

The paint with a polyurethane base is applied on the smooth concrete surface. Several standard colours are available or on request, according to Amop colour pallet chart.



IP B299
VERMELHO
RED



IP E230
LARANJA
ORANGE



IP Z319
AMARELO
YELLOW



IP F445
VERDE
GREEN

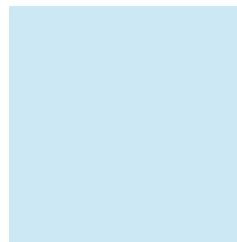

IP S419
AZUL
BLUE



IP M231
CASTANHO
BROWN

LISO PIGMENTADO

SMOOTH PIGMENTED

A superfície que sai do molde é deixada intacta, mostrando apenas a goma do betão.

The surface coming out of the mould is left untouched, showing only the concrete skin.

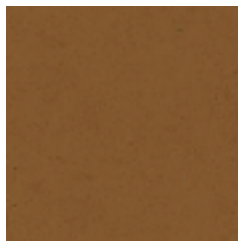

400 CS
BETÃO CASTANHO
BROWN CONCRETE



400 CM
BETÃO CREME
CREAM CONCRETE

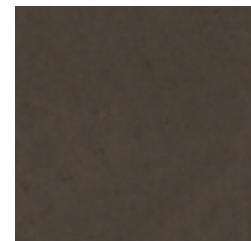

400 NG
BETÃO NEGRO
BLACK CONCRETE



400 BR
BETÃO BRANCO
WHITE CONCRETE



400 CZ
BETÃO CINZA
GREY CONCRETE

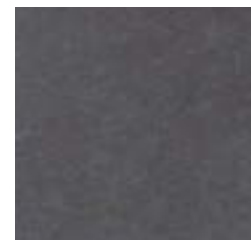

400 AT
BETÃO ANTRACITE
ANTHRACITE CONCRETE

BUJARDADO SUAVE SANDBLASTED

Superfície de aspeto liso rugoso mate.
Acabamento que se assemelha ao aspeto da pedra natural jateada homogénea.

Smooth matte rough-looking surface.
Finish that resembles the look of a homogeneous sandblasted natural stone.



470 BR
BRANCO
WHITE

470 CM
CREME
CREAM

470 CZ
CINZA
GREY

470 CS
CASTANHO
BROWN

470 NG
NEGRO
BLACK

BUJARDADO SHOT BLASTED

Acabamento de textura rugosa de elevada aderência.
Acabamento que deixa visível os agregados do betão.

Highly adherent, rough textured finishing, that makes visible the concrete aggregates.



475
PEDRA LIOZ
"LIOZ" STONE

455
GRANITO AMARELO
YELLOW GRANITE

445
GRANITO AZUL
BLUE GRANITE

405
PEDRA CASTANHA
BROWN STONE

425
GRANITO NEGRO
BLACK GRANITE

DESBASTADO HONED

Superfície de aspeto liso, mate.
Acabamento que se assemelha ao aspeto da pedra natural serrada.

Smooth matte appearance surface. Finishing similar to sawn stone appearance.



475 P
PEDRA LIOZ
"LIOZ" STONE

455 P
GRANITO AMARELO
YELLOW GRANITE

445 P
GRANITO AZUL
BLUE GRANITE

405 P
PEDRA CASTANHA
BROWN STONE

425 P
GRANITO NEGRO
BLACK GRANITE

BETÃO CS / ES

CAST STONE / ENGINEERED STONE CONCRETE

O betão CS | ES (Cast Stone | Engineered Stone) é um betão arquitetónico armado com aço nervurado, composição reológica pétreia de granulometria fina e de tonalidade aproximada à coloração final do objecto a betonar. As superfícies são devidamente tratadas com rejunte da micro-porosidade aberta do betão, com filler fino, formando uma superfície isenta de poros.

VANTAGENS-CHAVE

- Elevada Resistência ao Envelhecimento
- Elevada resistência à compressão
- Resistente a chuvas ácidas
- Elevada durabilidade e baixo custo de manutenção
- Inertes naturais à cor e granulometria fina
- Elevado grau de personalização de massas de betão
- Elevada resistência à corrosão
- Resistente ao vandalismo
- Resistente a variações meteorológicas
- Matéria-prima de origem controlada e certificada
- Acabamento final manual (Hand Made)

ACABAMENTOS

- Betão: Liso pintado / Liso pigmentado / Desbastado / Bujardado / Bujardado Suave
- Verificar Mapa de Cores e Carta de Acabamentos

TRATAMENTOS

- Hidrofugado
- Anti-graffiti
- Verniz de poliuretano

CS|ES concrete (Cast Stone | Engineered Stone), is an architectural concrete, reinforced with corrugated steel, stone rheological composition of fine particle size and colour tone close to the final coloration of the object to be concreted. The surfaces are properly treated with grout from the concrete's open micro-porosity, with fine filler, forming a porous-free surface.

KEY ADVANTAGES

- High Resistance to Aging
- High Resistance to Compression
- Resistant to acid rains
- High durability and low maintenance cost
- Natural inerts to color and finely grained
- High degree of customization of concrete grout
- High Resistance to corrosion
- Resistant to vandalism
- Resistant to meteorological variations
- Controlled and certified origin of raw materials
- Handmade finishing

FINISHINGS

- Concrete: Smooth painted / Smooth pigmented / Honed / Shot Blasted / Sandblasted
- Check Colors and Finishing Charts

TREATMENTS

- Waterproof
- Anti-graffiti
- Polyurethane varnish



aresta viva
sharp edge

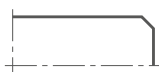

aresta biselada
beveled edge



aresta boleada
rounded edge

Alguns acabamentos poderão determinar o tipo de aresta.
Some finishes may determine the type of edge.

Qualquer produto poderá ter sistema de fixação ao solo.
Any product may have a ground-fixation system.

REVESTIMENTO PROTETOR *PROTECTIVE COATING*

A AMOP disponibiliza um revestimento protetor denominado Covercrete, com característica uniformizadora natural para o betão branco e cinza. Trata-se de um protetor de intempéries, retardador de envelhecimento e facilitador de auto-limpeza.

AMOP offers a protective coating called Covercrete, with a natural uniformizing characteristic for white and grey concrete. It is a weather protector, aging retardant, and self-cleaning facilitator

ACABAMENTOS COVERCRETE COVERCRETE FINISHES

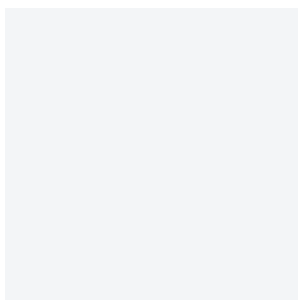

Branco
White

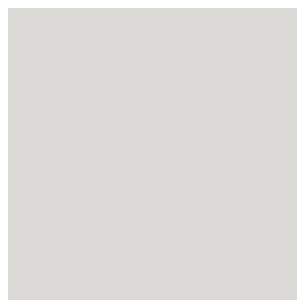

Cinza
Grey



GARANTIA AMOP

AMOP WARRANTY

A garantia dos materiais é prestada pelo seu desempenho face aos requisitos funcionais, estéticos e de adequação à utilização prevista, assim como a sua resistência à exposição aos agentes meteorológicos e às alterações climáticas.

Além da garantia legal do fabricante de 3 anos, são prestadas, no mobiliário urbano, garantias aumentadas aos materiais cuja qualidade e processo de acabamento garantam a sua estabilidade ao longo do seu ciclo de vida.

The materials' guarantee is assured by their performance against the functional, aesthetic and suitability requirements for the intended use, as well as their resistance to exposure to meteorological agents and climate change.

Beyond the 3 years legal manufacturer warranty, increased guarantees are provided on urban furniture for materials whose quality and finishing process ensure their stability throughout their life-cycle.

Mobiliário Urbano *Urban Furniture*

3 Anos 3 Years	5 Anos 5 Years	10 Anos 10 Years
<ul style="list-style-type: none"> - Betão liso pigmentado Smooth pigmented concrete - Madeiras Woods - Aço metalizado pintado Painted metallic steel 	<ul style="list-style-type: none"> - Betão liso pintado Smooth painted concrete - Aço galvanizado Galvanized steel - Plástico reciclado Recycled plastic - Compósitos tipo HPL HPL composites 	<ul style="list-style-type: none"> - Betão bujardado Shot blasted concrete - Betão desbastado Honed concrete - Betão bujardado suave Sandblasted concrete - Aço inox Stainless steel - Aço corten Corten steel

Exclusões:

- Incumprimento dos termos definidos nas condições gerais de venda; Características naturais dos materiais, dos acabamentos e tratamentos; Danos causados por incorreto manuseamento, transporte, instalação ou utilização; Elementos, partes e componentes de ligação não condutores com o mesmo material; Danos resultantes do não cumprimento das recomendações do fabricante e/ou do plano de manutenção, limpeza e proteção quando aplicável; Garantias não acumuláveis.

Exclusions:

- Failure to comply with the terms defined in the general sales conditions; Natural characteristics of materials, finishes and treatments; Damage caused by incorrect handling, transport, installation or use; Non-conductive connecting elements, parts and components made of the same material; Damage resulting from failure to comply with the manufacturer's recommendations and/or maintenance, cleaning and protection plan, when applicable; Non-cumulative guarantees.



ÍNDICE REMISSIVO

REMISSIVE INDEX

URBAN

ADD-ONS	148
ÁGUEDA	102
ALGECIRAS	145
AM	96
AMENO	50
AMOPLAY	26
AR PURO	18
AR PURO +	22
AVEIRO	140
BASICS	58
BENAVENTE	35
CAMDEN	139
CELL FORMS	40
CITIZEN	98
COIMBRA	78
COMPORTA	142
CONFORT	118
CRU	134
DNA	44
DOLMA	46
E'LEVE	73
EXERCISE	30
FRAME	128
FRESTA	113
GEOMETAL	106
GÓIS	126
GRIP	52
HYBRID	104
IK	144
LANDSCAPES	36
LC	147
LINK	137
LIVRE	45

LORD	80
LUGAR COMUM	86
MATADI	42
MATEUS	100
MIA	94
MINI RAMPS	157
MINIMAL	85
MODO	48
MODULAR	54
MUL	122
MUNDA	112
OBLONG	84
PARKLETS	165
PLANO	82
PUMP TRACKS	152
R7M	146
R-LIGHT	70
SOCIAL PLAY	74
SPINNER	138
TEJO	114
TOKYO	120
VOUGA RIO	124
WAVE RAMPS	161
WISE	136

PRIVATE

DEGRAU	181
FLOW	178
LAREIRA	181
MEGA-LAJETAS	180
ORIGAMI	183
ROUND UP	170
SALINAS	182
SCREEN	172

MONO K PAVINGS

ACESSÓRIOS	
PISCINAS	209
COMPLEMENTOS	197
CONCRETE_STONE	200
DEGRAUS E	
RODAPÉS	211
DIAGONAL	194
DISTINTUS	
ACETINADO	186
DISTINTUS	
DESBASTADO	188
ESTEREOTOMIAS	212
ESTILHADUS	190
GRANALHADUS	204
LONGUS	206
PAVIMENTO TÁTIL	216
SAND_STONE	198
TIRA	193
TIRA	210
TIRA BETÃO	196
TOSKANA	208

Informação sobre as medidas

As medidas estão referenciadas como C x L x A (Comprimento, Largura, Altura).

○ mobiliário apresenta as medidas visíveis acima do solo, devendo ser consultada a ficha técnica.

○ raio informado no mobiliário curvo é exterior.

Measurement information

Measurements are referenced as L x W x H (Length, Width, Height).

The furniture has visible measurements above the ground, and the technical sheet should be consulted.

The radius informed in the curved furniture is exterior.

Nota

As cores deste catálogo são apenas indicativas.

Todos os produtos cimentícios podem sofrer do fenómeno de eflorescências. Trata-se de um fenómeno natural.

Remark

The colours show in this catalogue are for guidance only.

All of the cement based products can suffer the phenomenon called efflorescence. This is a natural phenomenon.

amop[®]
synergies

Amop, Lda.

R. Chão Redondo, 258, Apt. 38
3754-906 Aguada de Baixo
Águeda - Portugal

GPS

N 40 30.837, W 8 26.465

234 667 957

amop@grupoamop.com

Export Contacts

+351 234 661 904

+351 234 661 903

export@grupoamop.com

www.grupoamop.com

